

安裝及操作說明書

洗衣機

Y_CDJT^

Gala

第 1 章：使用洗衣機前	
• 正確使用	4
• 一般警告	6
• 安全警告	7
• 包裝和環境	10
• 節約資料	10
第 2 章：設備的概述	
• 一般外觀	11
• 技術規格	13
第 3 章：安裝	
• 移除運輸安全螺絲	14
• 調整可調校的機腳	16
• 電力連接	17
• 入水管連接	18
• 排水連接	19
第 4 章：簡介控制面板	20
• 洗滌劑抽屜	21
• 程式旋鈕	23
• 電子顯示	24
第 5 章：衣物洗滌的前期準備	
• 分類洗滌衣物	25
• 洗滌衣物放入洗衣機	27
• 洗衣劑加入洗衣機	28
• 洗衣機的操作	28
• 輔助功能	30
• 兒童安全鎖	36
• 取消程式	37
• 完成程式	37
第 6 章：程式表	38
第 7 章：洗衣機的保養和清潔	
• 警告	42
• 入水過濾網	43
• 氣泵過濾網	44
• 洗滌劑抽屜	46
第 8 章：沖洗器塞子 / 機身 / 滾桶	47
第 9 章：排除故障	48
第 10 章：自動錯誤警告及補救事項	52
第 11 章：實用資料	53
• 棄置舊機	56

- 必閱讀用戶手冊。
- 本機是專為家庭使用。商業使用會令你的保養被取消。



- 讓您的寵物遠離洗衣機
- 在安裝前請檢查洗衣機的包裝，及打開包裝後的表面。切勿操作損壞的機器或包裝被打開的機器。
- 只能由授權的安裝服務安裝洗衣機。由任何非授權人員安裝你的洗衣機，將導致您的保養無效。
- 本產品不適合使用者（包括兒童）身體，感官或精神上有障礙或缺乏安裝經驗和知識的人士，除非有監督或指導者使用本產品以確保使用者的安全。應照看好兒童以確保他們不要拿洗衣機來玩耍。
- 使用你的洗衣機，請使用生產商指定適合洗滌濟去洗衣物。

• 使用洗衣機前取下 4 枚運輸螺絲，和洗衣機後面的橡膠隔片。如果不移除螺絲，它可能會造成嚴重的振動，噪聲和令產品出現故障或保養失效。

- 任何外在因素（殺蟲劑，火災等）引致的故障，機器都不在保養範圍內。
- 請不要扔掉本用戶手冊；請妥善保存以備日後參考。你或其他人將來可能會需要它。

注意：機械規格可能有所不同，視乎購買的產品。

- 冰冷的軟管可以撕裂和爆裂。在溫度低於零度的區域中，環境溫度可能危及電子零件的安全運作。

- 請確保將放置洗衣機的衣服口袋裏，不包含任何異物（釘，針，硬幣，打火機，火柴，夾子等）。這些外來物品可能會損壞你的洗衣機。

- 開始使用洗衣機前，你可電召最近的授權服務代表，並要求免費的安裝、操作和使用洗衣機的幫助。

- 建議第一次進行 90° 棉質程式清洗操作，並沒有洗衣物，在洗滌劑抽屜第二隔加入 ½ 分量的洗滌劑。

- 由於洗衣粉或柔順劑時間長暴露在空氣中，可能會導致有殘留物，在每次開始洗滌時，先把洗滌劑或柔順劑放在洗滌劑抽屜裏。

- 如果你長時間不會使用洗衣機，建議你拔掉機器插頭，並關閉進口水龍頭。此外，打開洗衣機的門會防止因濕度形成不良氣味。

- 在質量控制程序進行的試驗和測試後，有些水可能會留在洗衣機內。這不會損壞機器。

- 請記住您的機器包裝物料，可能危害兒童。包裝物料保存在孩子們不能接觸的地方或適當地棄置。

- 保存細小零件遠離兒童和嬰兒接觸到的地方。

- 只在非常骯髒的衣物，使用預洗程式。

- 當洗衣機操作期間，切勿打開清潔劑層格。

- 一旦發生任何故障，首先拔掉電器插頭，再關閉水龍頭。請勿嘗試自行維修，隨時聯繫授權的服務及諮詢。

- 放入洗衣機的洗衣量不應該超過指示的最大容量。

- 當機器正在運行，切勿強行開啓機門。

- 洗衣機內清洗蓋滿粉狀的衣服，會損壞機器。不要在洗衣機內清洗蓋滿粉狀的衣服。

- 請遵守清潔劑 / 織物柔順劑製造商的建議，在洗衣機使用織物柔順劑或類似產品。

- 設置洗衣機在機門可以完全打開的地方。（不要設置洗衣機在機門不能完全打開的地方。）

- 設置洗衣機在通風和有恆定空氣循環的地方。

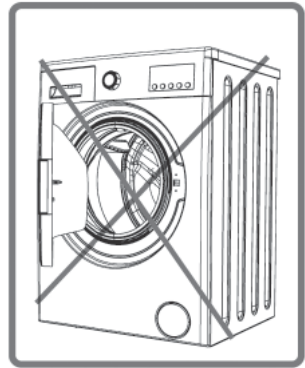
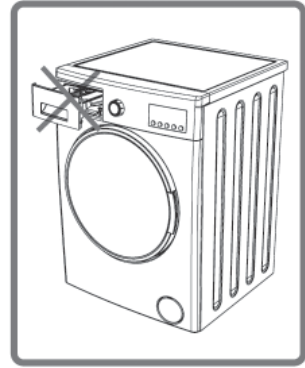

您必須閱讀這些警告。從而保護自己和心愛的人，防止致命傷害和風險



危險被燒焦的！

在洗衣機排水時，不要觸摸排水軟管和水，在運行時機器會達到很高的溫度。



電流引致死亡風險！



• 不要使用萬能插頭或拖板。

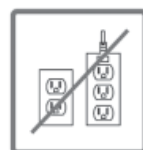

• 請勿插入損壞或破損插頭。

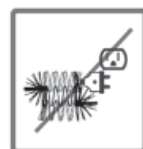

• 切勿拉扯電纜拔插頭 - 要抓住插頭位。

• 請勿濕手從插座插上或拔下插頭，以防止觸電！

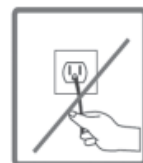

• 切勿用濕手或腳觸摸洗衣機。

• 如果電線故障，聯絡最近的授權服務中心進行更換。

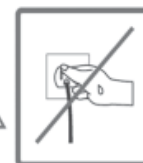

水浸風險！

- 檢查是否有水流出或沒有放置排水軟管在水槽。
- 採取必要措施，防止軟管滑掉。
- 軟管沒放置適當位置。防止水盆內的塞子堵塞排水孔。

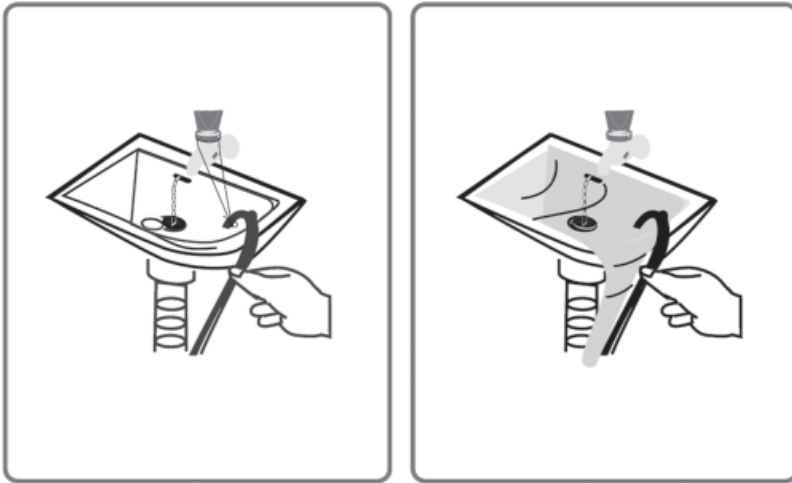

火災的危險！

- 不要把易燃液體靠近洗衣機
- 脫漆劑的硫磺物質可能會引起腐蝕。基於這個原因，切勿在洗衣機內使用去除油漆物料。
- 切勿在洗衣機內使用含有溶劑的物料。
- 衣物放入洗衣機時，取出洗衣物口袋裡所有物品（針，萬字夾，打火機及火柴等）。



跌倒和受傷的危險！



- 不要爬上洗衣機上。機器上部可能會破壞和你可能受傷。
- 在安裝洗衣機時，整理的軟管，電線和包裝，否則你可能會絆倒和跌倒。
- 切勿倒置洗衣機，或在其一側。
- 切勿握著洗衣機凸出配件提起洗衣機（洗滌劑抽屜，機門）。這些部件可能破裂並導致你受傷。
- 安裝洗衣機後，如果不適當儲存軟管和電線，會有絆倒和受傷的風險。

洗衣機必須由 2 人或以上搬運。



兒童安全！

- 請勿讓兒童單獨留在洗衣機附近。兒童可能會把自己鎖入洗衣機，釀成死亡風險。
- 當洗衣機操作時，機門玻璃和表面可能極熱。因此，觸摸洗衣機可能傷害兒童的皮膚。
- 把包裝物料遠離兒童。
- 如果使用洗滌劑和維修物料，可能發生中毒，如接觸到皮膚，眼睛或皮膚可能被受擾。保持清潔物料遠離兒童接觸到的地方。



去除包裝物料

包裝物料可以保護你的電器在運送期間發生損害。包裝物料可保護環境，因為它們是可循環再用。回收物料可提供節省原料和減少產生廢物。



棄置舊機

電力或電子化的舊設備可能仍包含能利用的部分。所以，切勿當廢物扔掉你的舊設備。

請確保把你的舊電子零件或電力設備給予收集中心相關部門。

為了孩子的安全，請確保你的舊電器儲存在適當地方，直到電器被取出屋外。

第 1 章：使用洗衣機前－節約資料

一些重要信息，令你從洗衣機獲得更多的效能：

- 放入洗衣機的洗滌衣物量，不應超過最高指示量。這樣，你的機器應進行節約模式。
- 不要為少許和正常骯髒的衣服使用預洗功能，應該節約用電和用水。

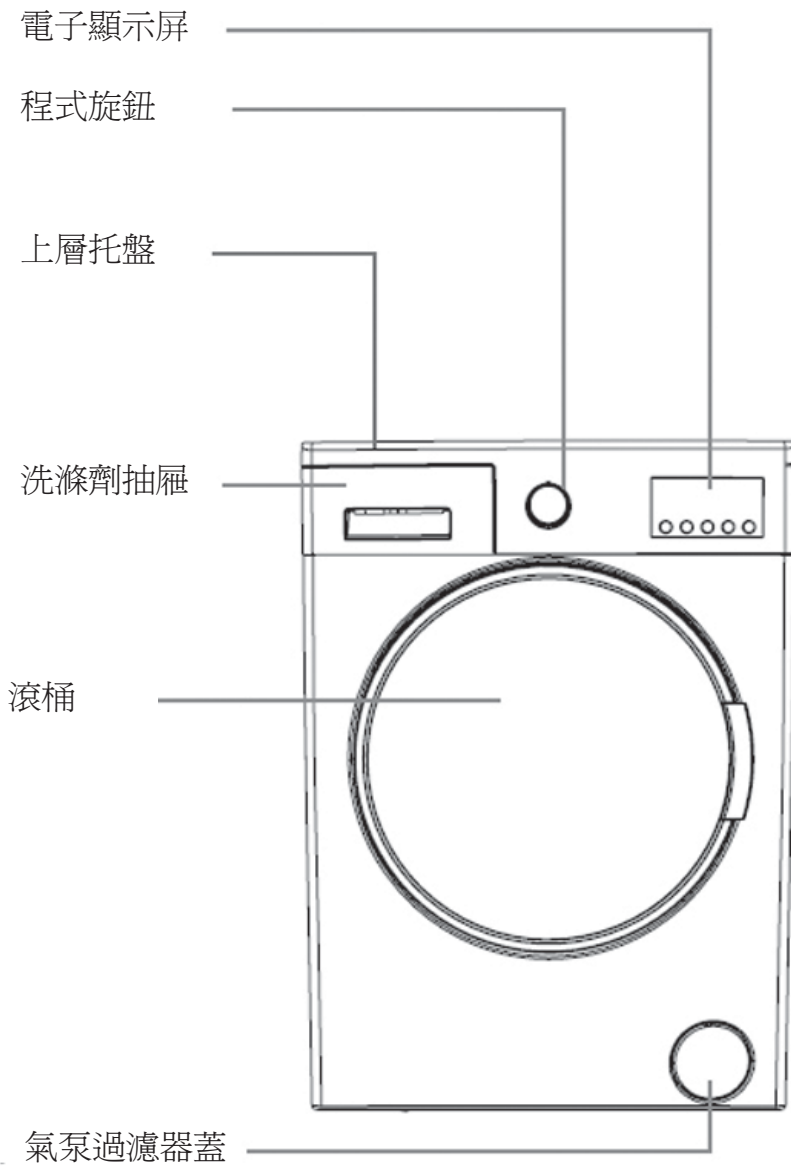

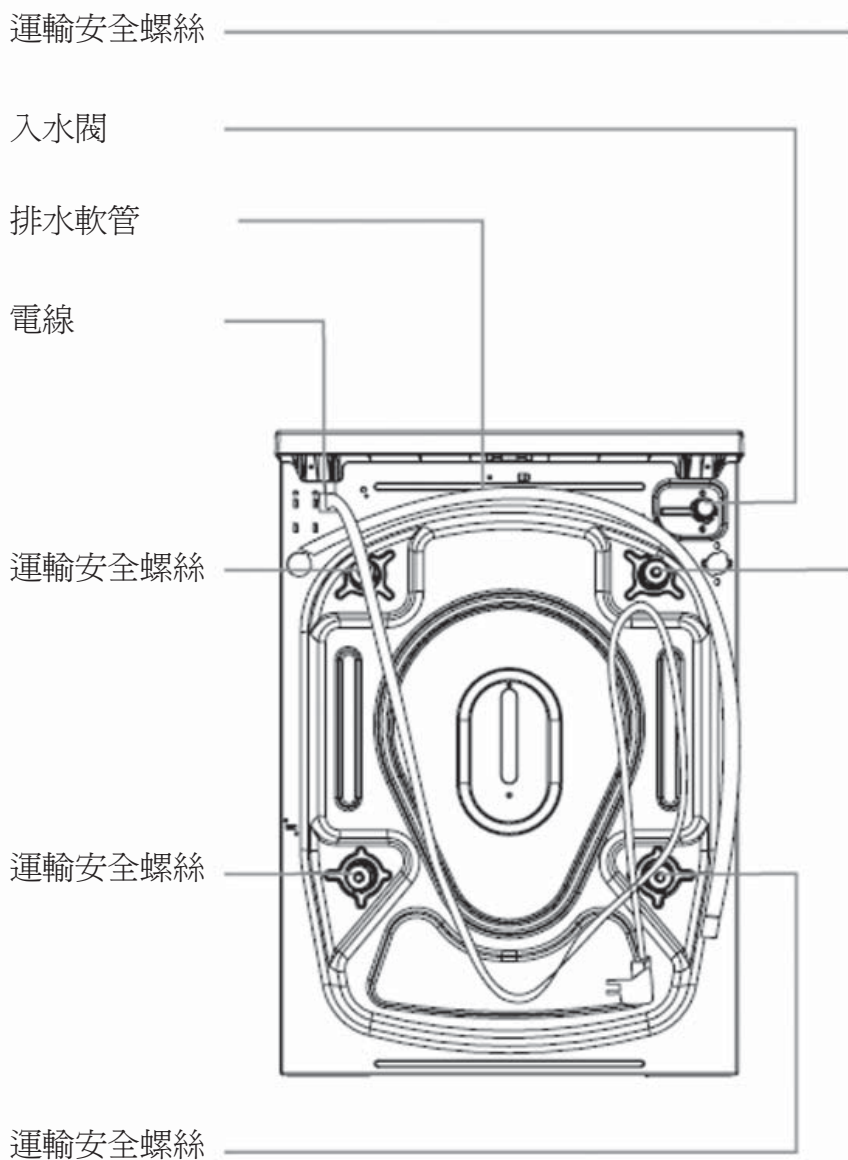

操作電壓 / 赫茲	(220-240)V~/50Hz
總電流 (安培)	10
水壓	最高 1Mpa 最低 0.1Mpa
總功率 (瓦特)	DDBB
最大乾衣重量 (公斤)	J
旋乾轉動 (轉 / 分)	1200
程式次數	15
外形尺寸 (高 x 寬 x 深) (毫米)	845 x 597 x 561



洗衣機操作前，取出 4 枚運輸螺絲釘和機背的膠墊。如果不取出螺絲，它可能會造成嚴重的震動， 噪聲和產品故障，（保養失效）。

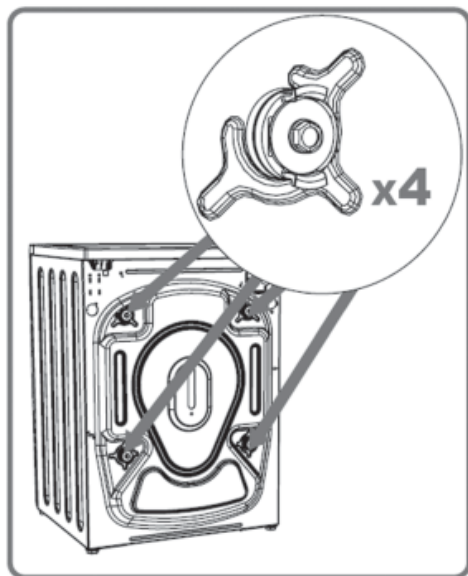

基於這個原因，應使用合適的扳手，以逆時針轉動鬆脫螺絲。

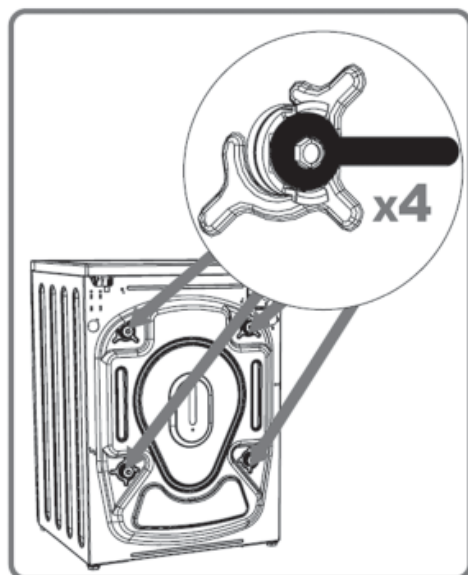

拉出運輸螺絲。

附件袋中的塑膠運輸螺絲蓋，裝設於取出運輸螺絲位置。

應儲存運輸安全螺絲，再次搬運時使用。

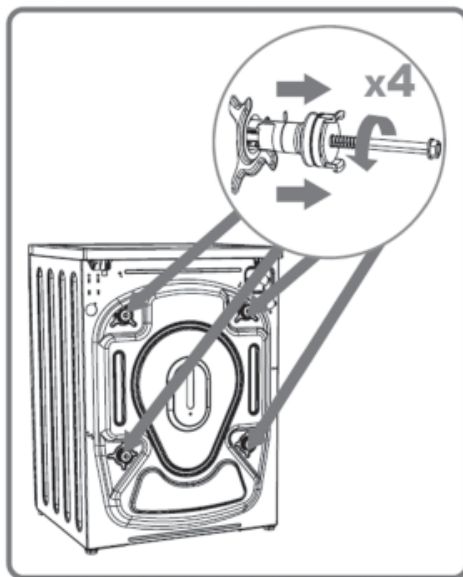

注意：第一次使用洗衣機前，你應完全取走運輸螺絲。設有螺絲的洗衣機，操作時會產生的錯誤，或保養失效。

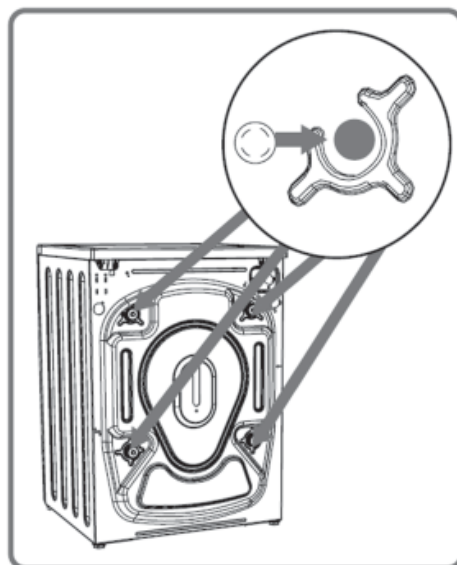

調整可調校的機腳

- 不要在地氈或相若的表面安裝洗衣機，這將防止底部的通風。
- 爲了洗衣機可運作寧靜和沒有任何震動，應把洗衣機放置在平而不滑和堅硬的地面上。
- 你可用機腳調校洗衣機的平衡。
- 鬆開塑膠調節螺母。

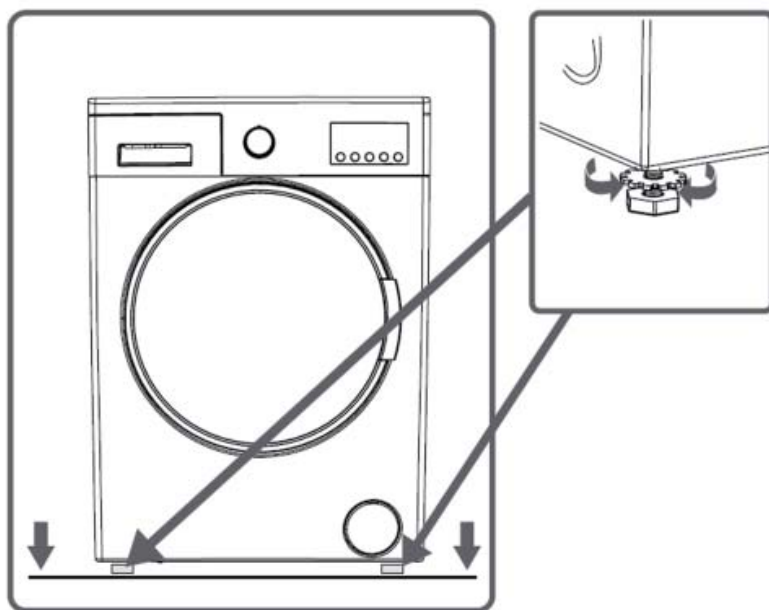

調整可調校的機腳

- 向上或向下轉動機腳來調校。
- 當得到平衡後，向上轉動塑膠調校母來扭緊。

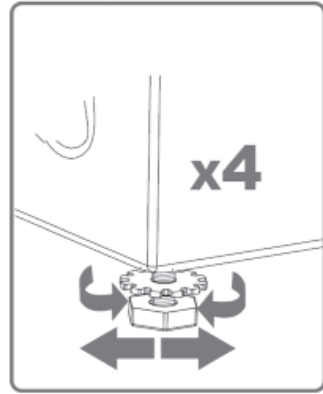

- 切勿在洗衣機下放置紙板、木塊或相若的物料來平衡不平地面。
- 當清潔洗衣機放置的地面時，小心不要紊亂機腳的平衡。

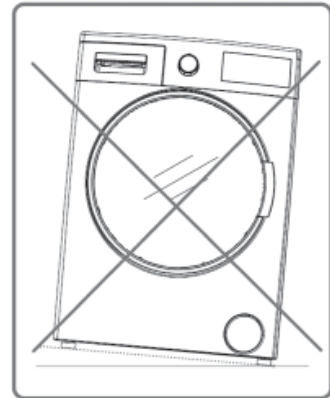

第 3 章：安裝－電力連接

- 洗衣機設置為 220-240V 和 50Hz。
- 洗衣機的主要電源線配備特定的地線插頭。這個插頭應時常插入 10amps 的地線插座。保險器的電流值應為 10amps。
- 電源線接到插頭的保險絲電流值也應該是 10 安培。如果你沒有這樣的插座和保險絲，請由合格的電工裝設。
- 我們將不負責因沒有地線裝置而造成的損毀。

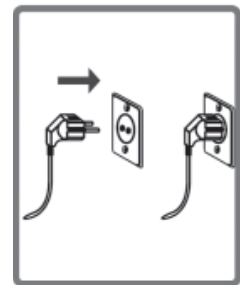

注：以低電壓操作洗衣機會減低洗衣機壽命和性能。

- 基於洗衣機規格，它可能有一個單一入口（冷）或雙入水口（冷 / 熱）。

白色頭水管應連接到冷水入口和紅色頭水管連接到熱水入口（適用於雙入水口洗衣機）。

- 要消除漏水的接觸點，軟管包裝附設 1 或 2 個螺母（適用於雙入水口洗衣機機）。在水龍頭側面的新入水管兩端，裝上這些螺母。

- 安裝新的進水管至 $\frac{3}{4}$ " 的螺紋的水龍頭。

- 連接白色曲尺入水管末端至洗衣機背面的白色過濾入水閥，和紅色曲尺末端至紅色過濾入水閥。（適用於雙入水口洗衣機）。

用手擰緊接駁口的塑膠配件。

在不確定的條件下，需由合格的水管技工來完成接駁工程。

- 流水的水壓是 0.1-1Mpa，讓你的洗衣機更有效地運作。（0.1Mpa 水壓代表每分鐘超過 8 公升水會流過一個打開的水龍頭。）

- 接駁後，確保完全開啓的水龍頭接觸點沒有洩漏。

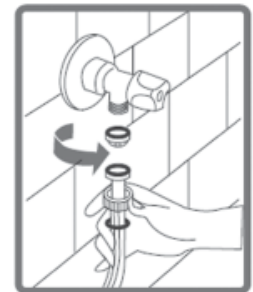
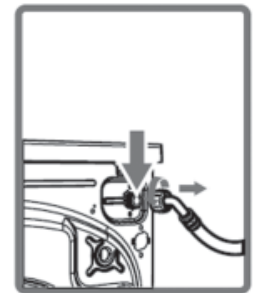
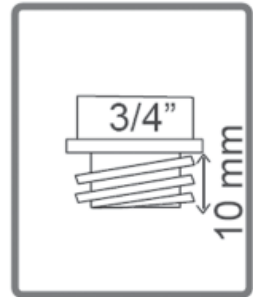
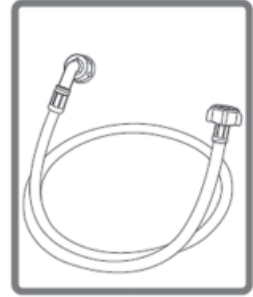

- 確保新的入水軟管沒有無彎曲，斷裂，撞裂和修改尺寸。
- 如果你的洗衣機設有雙熱水入口，熱水入口的溫度應最高 70°C。

注：當洗衣機接駁入水管時，只可使用洗衣機附設的新入水管。切勿使用舊的，使用過或損壞的入水管。

第 3 章：排水連接

- 排水管的末端，可以安裝在污水排放孔，或鋅盆臂的出口接位上的特定裝置。
- 切勿嘗試用接駁方法延長排水管。
- 不要把洗衣機的排水管放在一個容器，桶或鋅盆。
- 確保排水管沒有彎曲，緊扣，被擠壓或延長。請注意：
- 排水管應安裝在距離地面高度最少 60 厘米，最高 100 厘米。

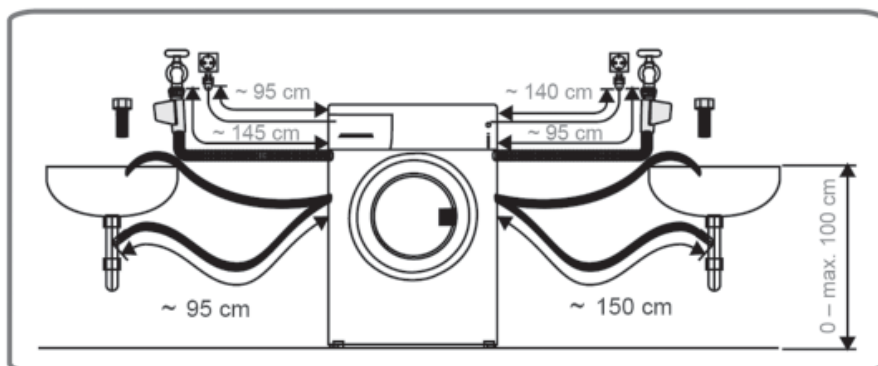

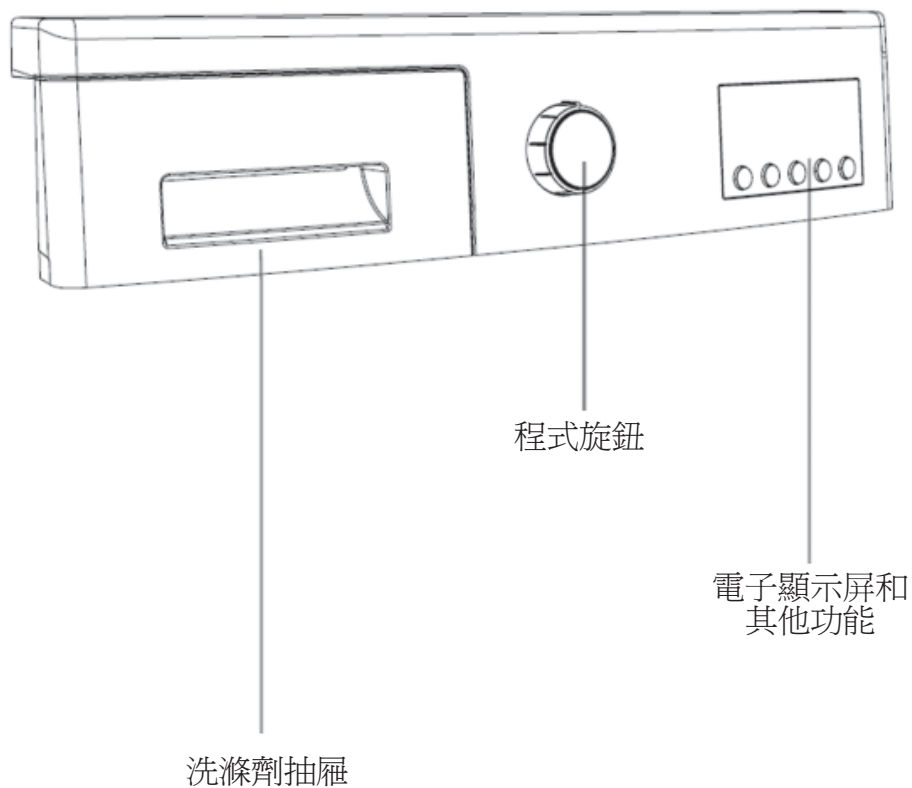

當你要使用液體洗滌劑清洗衣物，你可以使用液體水平測定板。你可以在所有程式中使用液體洗滌劑，而無需預洗。

將液體洗滌劑裝置放在洗滌劑抽屜（*）的第二隔（附設在機內），並設置洗滌劑量。（使用生產商建議的液體洗滌劑容量）。不要超過最高水平，裝置只適用於液體洗滌劑，不能用於洗衣粉和把它拿出來。）

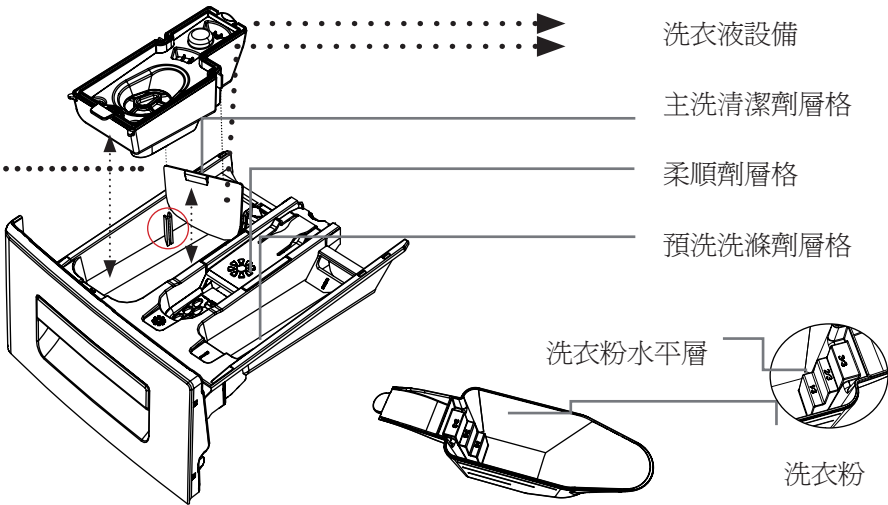
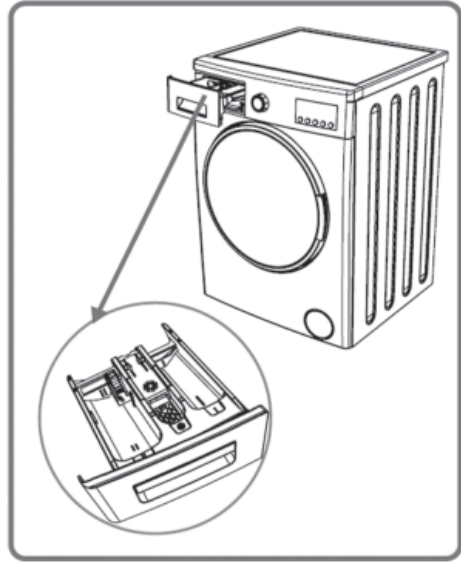

（*）機內配件會根據購買的產品型號有所不同。

部分

主洗洗滌劑層格：

在這層格，只有洗滌劑（液體或粉末），石灰防噴物料可以使用。

首次安裝（*），在洗衣機內可以找到液體洗滌劑裝置。

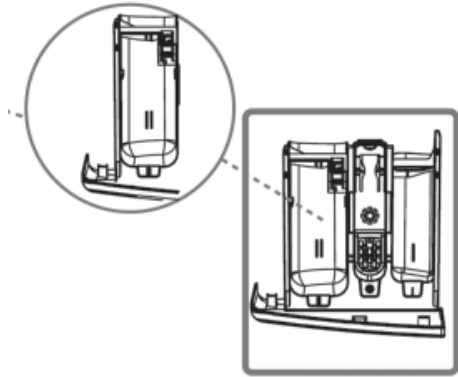

織物柔順劑，洗衣粉，洗衣劑層格：

你可以使用柔順劑洗衣服（生產商建議量和類型）。

有時織物柔順劑會留在層格。因為柔順劑不黏性的。為了防止這種情況，建議使用更黏性的液體軟化劑，先稀釋軟化劑才使用。

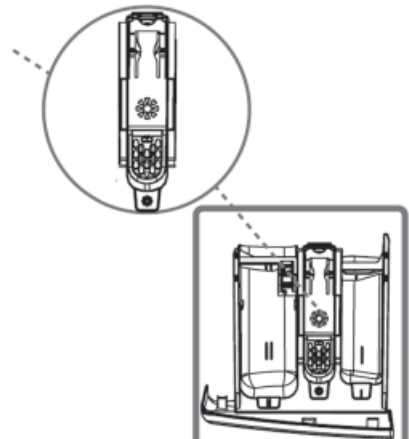

預洗洗滌劑層格：

此層格只能用於預洗功能。建議預洗功能用於非常骯髒的衣物。

（*）根據購買的產品型號，機內配件可能會有不同。

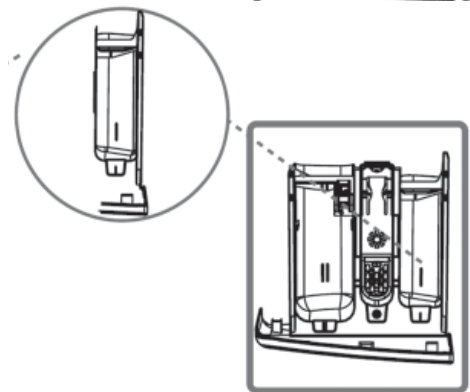

（*）機內配件會根據購買的產品型號有所不同。

- 你可以使用程式旋鈕選擇你要洗的程序。
- 你可以左右旋轉程式旋鈕，設定程式選擇操作。
- 確保程式旋鈕，停止你選擇的程式。

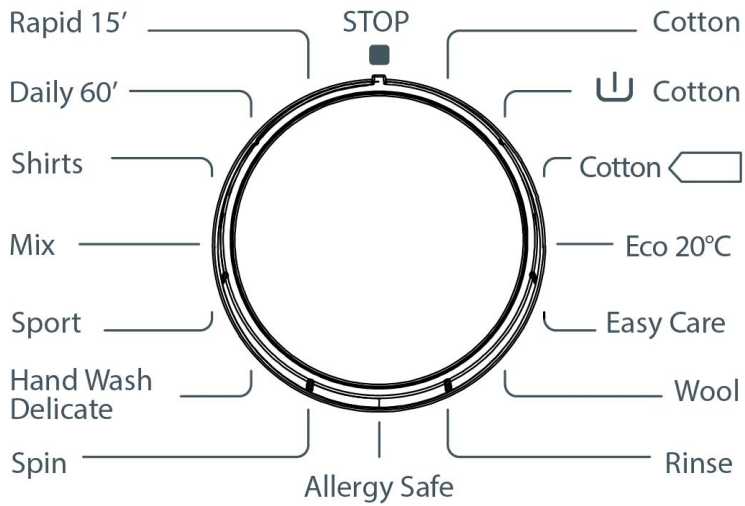

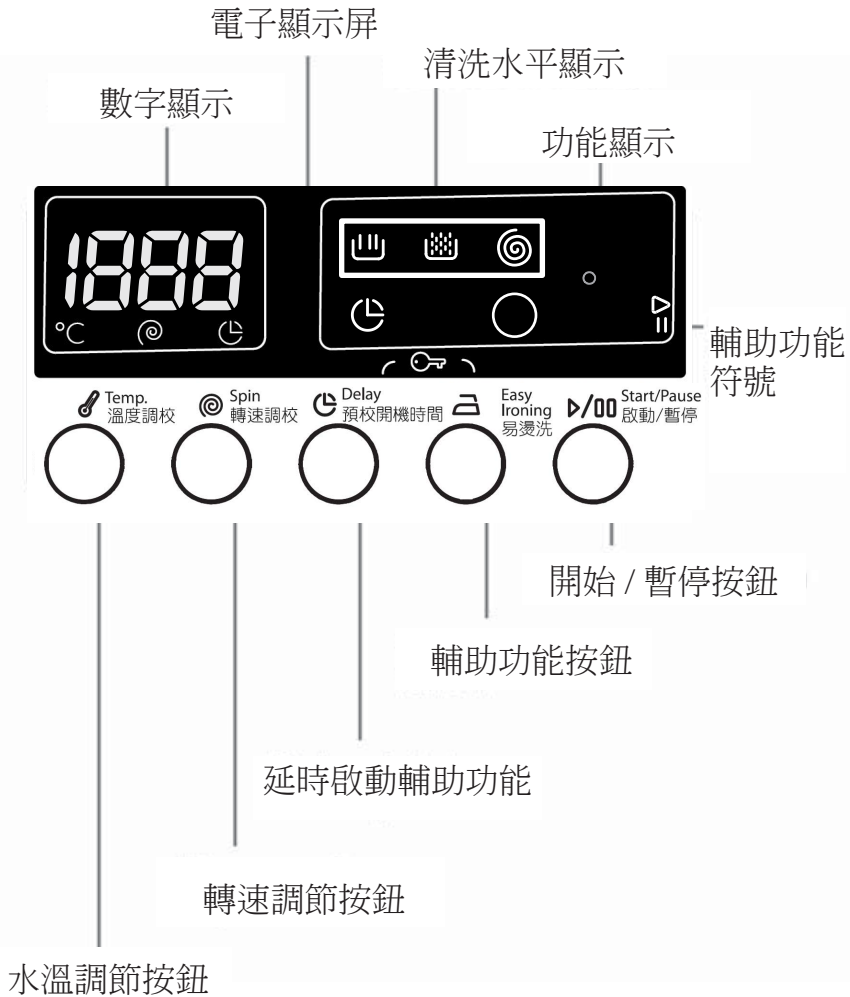

在電子顯示屏，你可以查看洗滌水溫度，洗衣機的旋轉轉速，當你的機器將完成清洗，你可看到你選擇的輔助功能和你已選的程式在什麼階段。

(冼) → 預洗 / 清洗 (齒) → 過水 (旋) → 旋轉

此外當故障發生時，電子顯示屏會在顯示屏上出現故障符號警告你。在你已選程式完結時，在顯示屏上出現 " 結束 " 通知你完成洗滌程式。

- 衣物上附有產品標籤指定指示。依照產品標籤上指示清洗或晾乾衣物。
- 依照衣物的種類來分類(棉質, 合成纖維, 羊毛等), 清洗水溫 (30°, 40°, 60°, 90°) 和骯髒程度 (少許骯髒, 骯髒, 十分骯髒)。
- 切勿把白色和顏色衣物一起清洗。
- 因顏色衣物在第一次清洗時脫色, 應把它和其他衣物分開清洗。
- 清理衣物的所有口袋, 確保沒有金屬物件留下。



注意：警告：因異物加入你的洗衣機而出現故障，都不列入保養範圍之內。



- 拉上拉鏈和扣好衣物。
- 除去薄紗窗簾或窗簾的膠質或金屬鉤, 或把它們放進洗衣網或衣物袋和綁好。
- 反轉紡織品, 如褲子, 針織服裝, T 恤和運動套裝。
- 把襪, 手帕等類似的細小衣物放在洗衣網。



 能漂白	 不能漂白	 正常清洗
 熨衫溫度 最高 150°C	 熨衫溫度 最高 200°C	 不可熱熨
 可乾洗	 可乾洗	 平放吹乾
 濕時掛起	 掛起吊乾	 不能扭乾
 可使用氣油、 淨酒精和 R113 乾洗	 四氯乙烯 R11、 R13、石油	 四氯乙烯 R11、 R113、氣油

- 打開洗衣機門。
- 把衣物平均分佈洗衣機。



注意：最大洗衣容量是基於洗衣服類型，骯髒程度和你選擇了的程式。不超過清洗程式的程式表列生的最大乾衣承載量。



你可以把以下的重量表作為一個例子。

洗衣類型	重量（克）
毛巾	200
亞麻布	500
浴衣	1200
被套	700
枕套	200
內衣	100
枱布	250

- 把每一件衣物分開。
- 當關上機門，小心衣物會卡夾在機門和墊片之間。
- 關門時，推洗衣機機門直至聽到鎖門聲。
- 緊閉機門，否則洗衣機不能開始運作。



放進洗衣機的清潔劑分量，視乎以下標準：

- 清潔劑用量是根據衣物骯髒程度。輕微骯髒的衣物，不用預洗和只需放少量清潔劑在抽屜的第 2 格。
- 十分骯髒的衣物，選擇有預洗的程式，放入 1/4 清潔劑分量在抽屜的第 1 格，剩餘的放在抽屜的第 2 格。
- 最好使用專為自動洗衣機而設計的清潔劑，分量已清楚列明在包裝紙上。
- 若水質硬度增加，清潔劑的分量也相對增加。
- 若清洗的衣物數量增加，清潔劑的分量也相對增加。
- 把柔順劑放進抽屜的柔順劑格層，不要超過最高位。否則，柔順劑會經沖洗器流至清洗的水中。
- 高濃度的柔順劑應在放進抽屜前被沖稀。因為高濃度的柔順劑會阻塞沖洗器和阻止柔順劑流動。
- 你可在任何沒有預洗的程式中，使用清潔劑。將包裝袋或清潔液裝置中的清潔液水平板放在清潔劑抽屜的第 2 層格，然後根據此板的水平位放入清潔液。記住取下清潔液板

(*) 機械規格會根據購買的產品型號有所不同。

第 5 章：衣物洗滌的前期準備 — 洗衣機的操作

- 洗衣機插上插頭
- 打開水龍頭。
- 打開機門。
- 展開洗衣機內的衣服。
- 推洗衣機機門，直到聽到關閉的鎖定聲音。

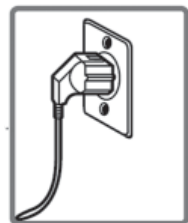

選擇程式

選擇程式表上方便的程式。

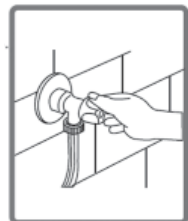

輔助功能

啓動程序前，可以隨意選擇輔助功能。

- 按下您想選擇的輔助功能按鈕。
- 如果在電子顯示屏上的輔助功能符號持續閃動，您所選擇的輔助功能將生效。
- 如果在電子顯示屏上的輔助功能符號亮著，您選擇的輔助功能將不會生效。

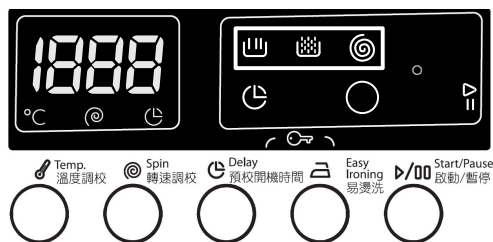

不生效的原因：

- 您想使用的洗衣程式的輔助功能不適用。
- 洗衣機已通過了階段，你想選擇的輔助功能被實施。
- 與你之前選擇的輔助功能不能兼容。

半容量檢測系統

你的洗衣機配有半容量探測系統。

如你把最大洗衣容量的大約一半或少量洗衣放入洗衣機，洗衣機會在某些程式進行節省洗滌時間，用水量和能量。

當半容量功能生效時，洗衣機可以在更短的時間完成你設定的程式。

1- “溫度”選擇

你可以用洗滌水溫調節按鈕選擇洗滌水溫。

當你選擇一個新的程式，最高的洗滌水溫會顯示在洗滌水溫顯示屏。

你可以按下洗滌水溫調節按鈕，在最高溫度和冷洗 (-) 之間，逐漸降低洗滌水溫。

如果你已經錯過了你想要的洗滌水溫度，你可以連續按下洗滌水溫調節按鈕，返回預定溫度。

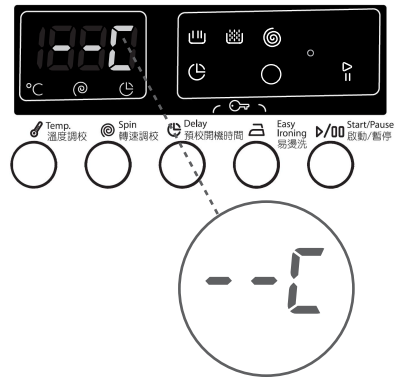
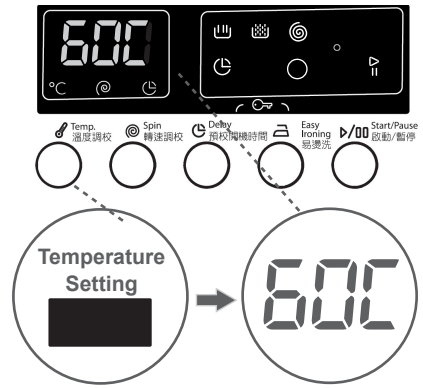

2-“脫水”轉速選擇

你可以使用旋轉設定按鈕，為你的衣物設定轉速。

當你選擇新的程式時，你可在旋轉顯示屏看到你選擇的最高旋轉轉速。

你可以按下轉速設定按鈕，在取消旋轉 (-) 選項至程式最高轉速之間，逐漸減少轉速。

如果你錯過了你想設定的脫水轉速，你可以持續按下轉速設定按鈕重設轉速。

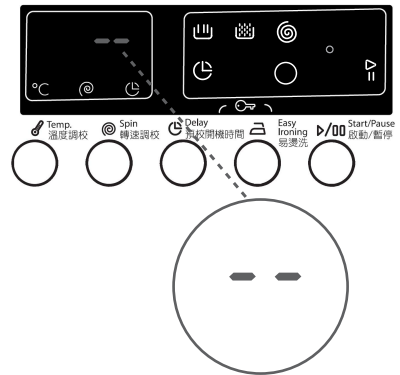
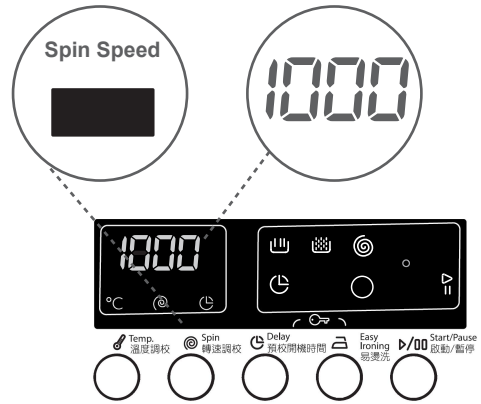

3- “延遲”定時器

通過使用這個輔助功能，你可以在洗衣機開始清洗時設定時間。這時間可以從一個小時至到 23 小時。

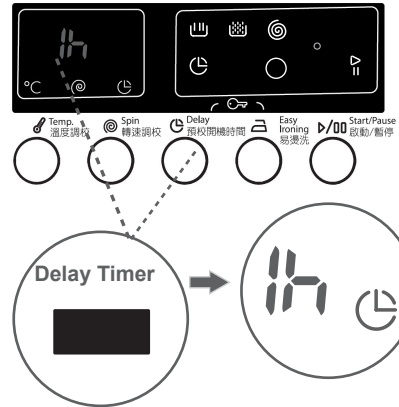

使用輔助功能 延遲計時器

- 按時間延遲按鈕一次。
- 在顯示屏上會出現“1小時”。符號  會在電子顯示屏上閃動。
- 按時間延遲按鈕，直到時間到你想要啟動洗滌操作時間。
- 要生效你在程式選擇的時間延遲，你可以按任何輔助功能按鈕，除了“啟動/待機”按鈕。

如果錯過你想設置的延遲時間，你可以持續按下時間延遲按鈕回到理想時間。

如果你想取消時間延遲，你只需要按一次延時按鈕。符號  不再在電子顯示屏閃動。

進行時間延時功能，需要按開始 / 暫停按鈕操作洗衣機。

4- 易於熨燙 (*)

洗滌操作完成通過採用此輔助功能，你可以讓衣物應取出時少皺摺。

當您按下易於熨燙輔助功能，符號  在電子顯示屏將閃動。

5- 防過敏 (*)

這輔助功能在程式中生效，洗衣機會在最後過水操作之進行一個額外過水操。

當你按下防過敏輔助功能，符號  在電子顯示屏將閃動。

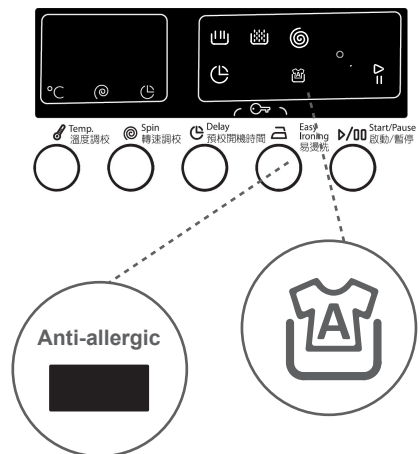
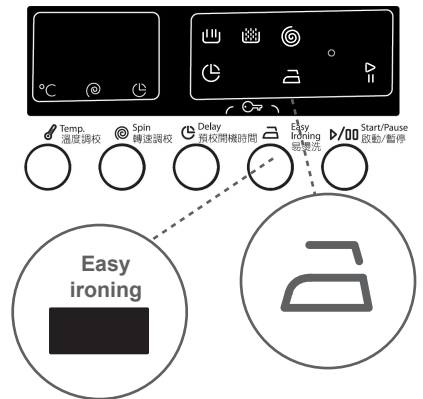

6- 快速洗衣 (*)

這個輔助功能令不是非常骯髒的衣物，縮短洗滌時間。

如果你放已選程式的一半或少於一半洗衣量進洗衣機，洗衣機會檢測到這種自動半載檢測系統和你所選擇的程序將在更短的時間，消耗更少的能源和用水清洗衣物。如果洗衣機檢測到半載時，符號  會自動在電子顯示屏閃動。

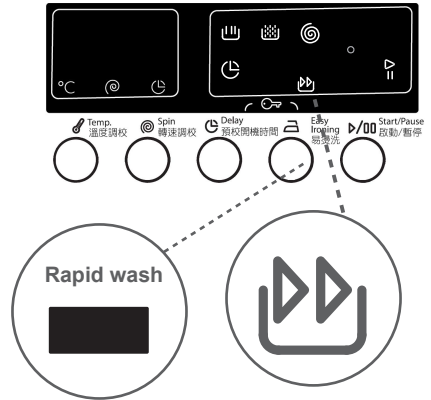

7- 預洗 (*)

你可以在主洗前，使用這預洗附加功能，清洗十分骯髒的衣物。當你使用此功能時，你應該把洗滌劑放在洗滌劑抽屜的預洗層格。

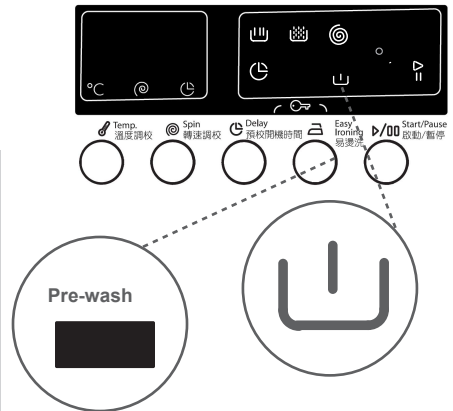

8- 過水⁺

你可以使用這個附加功能進行衣物額外過水。

你可以在符號燈亮著時按額外過水輔助功能按鈕開啓程式。

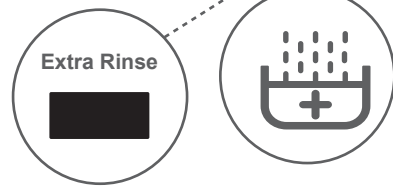
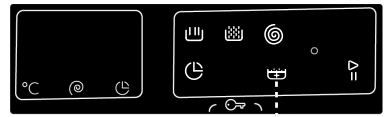

9-“開始/暫停”按鈕

按下開始 / 暫停按鈕，你可以啓動你選擇了的程式 或暫停進行程式。如果你切換洗衣機在待機模式，在電子顯示屏上會閃動 " 啓動 / 暫停 " 燈。

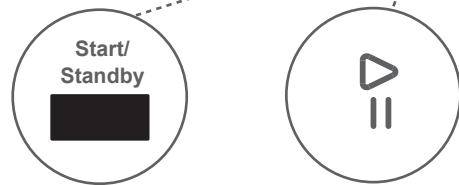
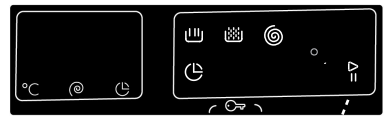

兒童鎖防止在洗衣機操作時，程式按鈕被按下影響了程式流程，或程式按鈕被轉動。

當輔助功能 3 和 4 同時被按下超過 3 秒，兒童鎖便會生效。

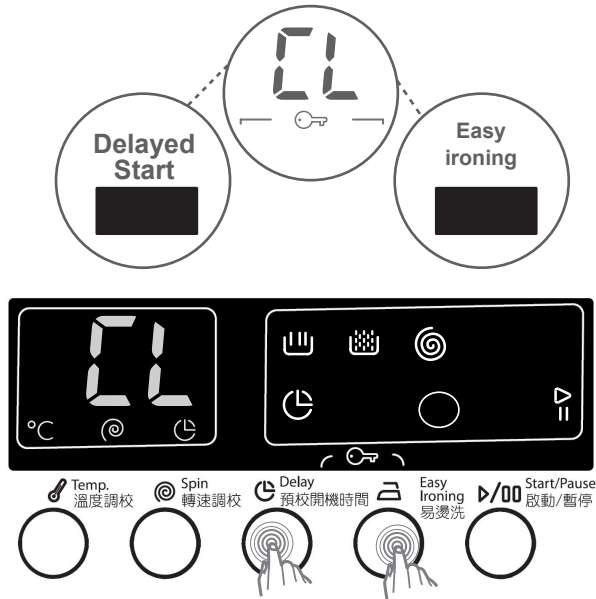

當生效時 "CL" 符號會在電子顯示屏上閃動。

如果當兒童鎖生效時按下任何按鈕，"CL" 符號會在電子顯示屏上亮著的。

如果在任何程式運行時，兒童鎖也進行，程序旋鈕切換到取消位置和其他程序被選擇了，先前選擇的程式會從離開的地方繼續。

要關閉它，只須按同一按鈕 3 秒以上。當兒童鎖被停用，在電子顯示屏上的 "CL" 符號會熄滅。

如果你想取消任何操作中程式：

- 1- 扭動程式旋鈕至“取消”的位置。
- 2- 洗衣機將停止清洗操作和程式會被取消。
- 3- 爲了消除洗衣機的積水，扭動程式旋鈕至任何程式。
- 4- 洗衣機會進行重要的排水操作和取消程式
- 5- 你可以選擇新程式令洗衣機運行。

第 5 章：衣物洗滌的前期準備 — 完成程式

當你選擇的程式完成，洗衣機會自動停止。

- “停止”將在電子顯示屏上閃動。

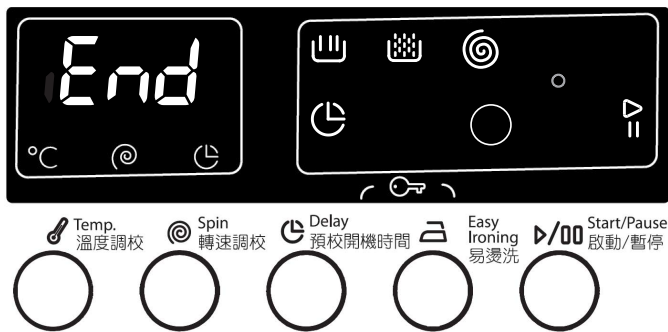

- 你可以打開機門，取出衣物。
- 取出衣物後，打開機門，讓洗衣機內部晾乾。
- 轉動程式旋鈕至取消位置。
- 拔掉洗衣機插頭。
- 關閉水龍頭。

棉質 90°

清洗溫度 (°C)	90°
最高乾洗衣量 (千克)	J,0
洗衣劑層格	2
程式時間 (分鐘)	CJ1
程式種類和描述	非常骯髒，棉質和亞麻紡織品。（內衣，床單，枱布，毛巾（最多 4,B 公斤），床上用品等。

棉質預洗⁺

清洗溫度 (°C)	60°
最高乾洗衣量 (千克)	J,0
洗衣劑層格	1&2
程式時間 (分鐘)	16G
程式種類和描述	骯髒棉質和亞麻紡織品。（內衣，床單，枱布，毛巾（最多 4,B 公斤），床上用品等。

棉質 60°

清洗溫度 (°C)	60°
最高乾洗衣量 (千克)	J,0
洗衣劑層格	2
程式時間 (分鐘)	2CG
程式種類和描述	骯髒棉質和亞麻紡織品。（內衣，床單，枱布，毛巾（最多 4,B 公斤），床上用品等。

節能 220°

清洗溫度 (°C)	20°
最高乾洗衣量 (千克)	4, B
洗衣劑層格	2
程式時間 (分鐘)	9G
程式種類和描述	少許骯髒，棉質和亞麻紡織品。（內衣，床單，枱布，毛巾（最多 2 千克），床上用品等。

注意：程式時段可根據洗衣量，水喉水壓，環境溫度和選擇的附加功能而改變。

輕柔衣物

清洗溫度(°C)	40°
最高乾洗衣量(千克)	3.5
洗衣劑層格	2
程式時間(分鐘)	110
程式種類和描述	非常骯髒或合成混合紡織品。(尼龍襪，恤衫，女式襯衫，合成物包括褲子等)

羊毛

清洗溫度(°C)	30°
最高乾洗衣量(千克)	2.5
洗衣劑層格	2
程式時間(分鐘)	43
程式種類和描述	附有機洗標籤的羊毛洗衣。

過水(冷)

清洗溫度(°C)	-
最高乾洗衣量(千克)	J.0
洗衣劑層格	-
程式時間(分鐘)	4D
程式種類和描述	清洗完成後，如果你想額外沖洗你的衣物，你可以使用此程序式清洗任何衣物。

防敏洗

清洗溫度(°C)	60°
最高乾洗衣量(千克)	4,B
洗衣劑層格	2
程式時間(分鐘)	2DH
程式種類和描述	嬰兒洗衣。

注意：程式時段可根據洗衣量，水喉水壓，環境溫度和選擇的附加功能而改變。

旋轉

清洗溫度 (°C)	-
最高乾洗衣量 (千克)	J.0
洗衣劑層格	-
程式時間 (分鐘)	17
程式種類和描述	清洗完成後，如果你想額外弄乾你的衣物，你可以使用此程序式清洗任何衣物。

手洗 / 纖幼

清洗溫度 (°C)	30°
最高乾洗衣量 (千克)	2.5
洗衣劑層格	2
程式時間 (分鐘)	90
程式種類和描述	建議手洗或敏感的衣物。

運動衣物

清洗溫度 (°C)	30°
最高乾洗衣量 (千克)	3.5
洗衣劑層格	2
程式時間 (分鐘)	80
程式種類和描述	運動服裝。

混合

清洗溫度 (°C)	30°
最高乾洗衣量 (千克)	3.5
洗衣劑層格	2
程式時間 (分鐘)	JC
程式種類和描述	骯髒棉質，合成織物，顏色和可一起清洗的亞麻紡織品。

注意：程式時段可根據洗衣量，水喉水壓，環境溫度和選擇的附加功能而改變。

恤衫

清洗溫度(°C)	60°
最高乾洗衣量(千克)	4.0
洗衣劑層格	2
程式時間(分鐘)	1CD
程式種類和描述	骯髒棉質，合成和混合合成恤衫和女襯衣可以一起清洗。

日常 60'

清洗溫度(°C)	60°
最高乾洗衣量(千克)	4.0
洗衣劑層格	2
程式時間(分鐘)	60
程式種類和描述	在 60 分鐘內，你可以清洗骯髒棉質和亞麻織物在 60°C。

快速 15'

清洗溫度(°C)	30°
最高乾洗衣量(千克)	2.0
洗衣劑層格	2
程式時間(分鐘)	15
程式種類和描述	在短短 15 分鐘，你可以清洗輕微骯髒棉質和亞麻織物。

注意：因為洗滌時段短，相對其他程式使用較少量洗滌劑。如果洗衣機檢測到不穩定的加載，將增長程式時段。你可以在清洗操作完成後 2 分鐘後打開機門。（洗衣機需要 2 分鐘時間打開機門，不包括在洗滌階段。）

注意：程式時段可根據洗衣量，水喉水壓，環境溫度和選擇的附加功能而改變。

開始保養和清潔洗衣機前拔掉插頭。

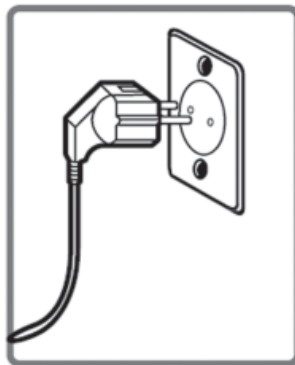

開始保養和清潔洗衣機前關掉水龍頭水。

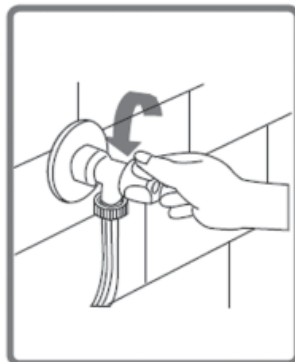

警告：如果使用含溶劑的清潔劑，你的洗衣機部件可能會受損。

請勿使用含溶劑的清潔劑。

入水管起端的水龍頭，至末端的活塞之間，放置了過濾網來防止污物和水中的其他物質進入洗衣機。如果洗衣機不能接收由水龍頭足夠的水，這些過濾網都需要清洗。

(建議兩個月清潔水泵過濾網一次)

移走入水管。

用鉗子移走在入水活塞的過濾網和用擦子在水中清潔。

用手拆走入水管的水龍頭端過濾網，然後清洗。

清洗過濾網後，可按照相反次序的方法，重新放回原位。

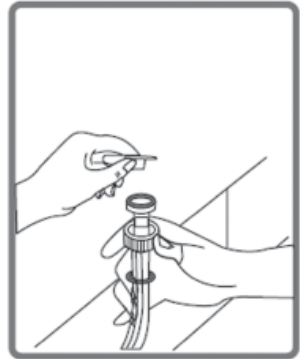
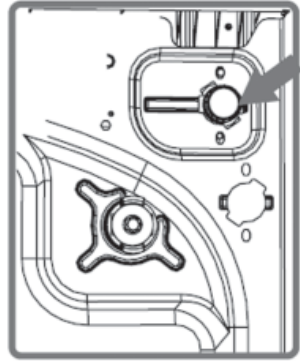

警告：

進水閥過濾器可能堵塞，原因是水龍頭被污染，或缺乏必要的保養或閥門已損壞了，造成不斷漏水入洗衣機。

因這些原因引致損壞，都不在保養範圍內。

過濾系統可防止衣物的絨毛和細小物件在洗衣完成後進行排水時進入水泵，從而延長水泵的壽命。每隔 2 個月就要清潔水泵過濾網。清洗水泵過濾網如下：

- 要打開水泵蓋，你可以使用洗衣粉刮(*)或洗衣液水平板取出。
- 用塑膠部分裝入氣泵蓋空位和向後推。這會打開蓋。
- 在打開過濾網蓋前，先放一個器皿在過濾網蓋前，以防止洗衣機剩餘的水流出。
- 把過濾網蓋向逆時針方向轉動鬆脫和排出水。

注意：你可能根據洗衣機水量，清潔器皿的收集水幾次。

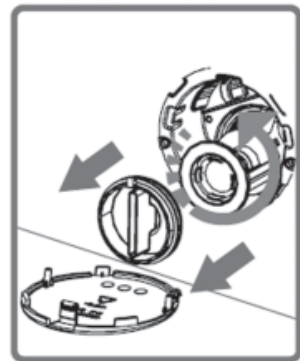
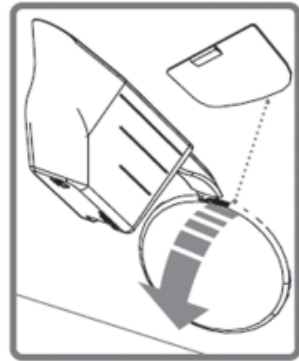

- 用擦清潔過濾網異物。



- 把過濾網清潔後，順時針方向轉動扭緊，重裝過濾網蓋。

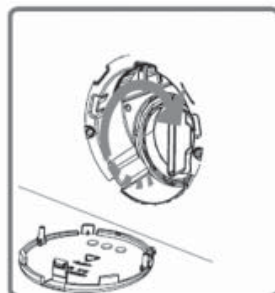

- 當關上氣泵蓋，確保蓋內的零件對準前板側的孔。

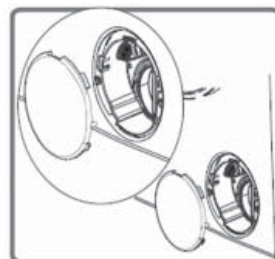

- 你可以倒轉取出時的次序重裝氣泵蓋。

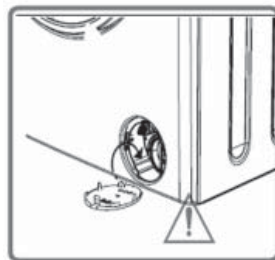

警告！

因水泵內的水可能很熱，要等它冷卻後才可作處理。

清潔劑可能殘留沉澱物於清潔劑抽屜，要清潔殘餘物，要定時拆開清潔劑抽屜。我們並且建議每 2 個月清潔水泵過濾網。

拉出清潔劑抽屜如下：

- 把清潔劑抽屜拉到盡。
- 用刷清洗殘留的清潔劑。
- 收集殘留物在清潔劑抽屜，以免污物跌入洗衣機。
- 用毛巾或乾布擦乾，然後放回清潔劑抽屜。

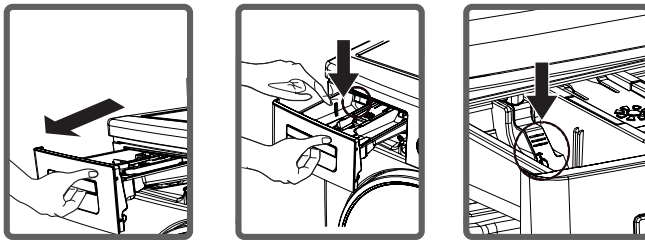

- 切勿將洗滌劑抽屜放進洗碗碟機清洗。

洗滌液設備 (*)

依照圖示取出用於洗滌液水平測定板和清潔殘留物，達到清潔和保養目的。把該裝置放回原位。確保沒有殘留物留在裡面。 (*) 洗衣機規格會根據購買產品有所不同。

注意：洗衣機規格會根據購買的產品型號有所不同。

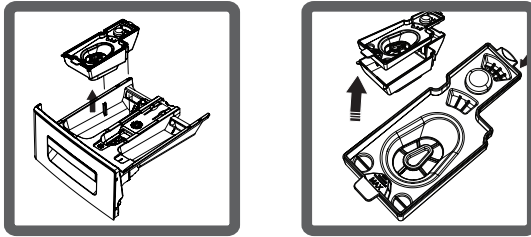

沖洗塞子

拉出清潔劑抽屜，移走沖洗塞子和徹底清洗殘留物。把清潔的沖洗塞子放回原位和檢查是否已放好。

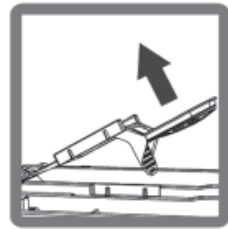

機身

用微溫的水和不含腐蝕性的清潔液，來清潔洗衣機機身的表面。清水過後，再用軟乾布抹乾。

滾桶

不要留下金屬物件如針，釘或硬幣在洗衣機內。這些物件會導致滾桶生鏽。要消除這些鏽漬，用一些沒有二元離子化合物的清潔劑和依照生產商指示使用。不要用洗碗碟的鋼絲刷或其他粗糙物來清理鏽漬。



應由合資格技工進行所有維修。如果洗衣機需要維修或根據以下資料也不能幫助解決疑難，請自行：

- 拔掉洗衣機插頭
- 關掉水龍頭

故障	可能的原因	解決辦法
機門沒有關好	插頭沒有插好	插好插頭
	保險絲斷毀	檢查保險絲
	沒有電源	檢查電源
	沒有按啟動 / 暫停按鈕	按下啟動 / 暫停按鈕
	程式旋鈕停在停止位置	把程式旋鈕轉至適合位置
	機門沒有關好	關好機門沒有，你應聽到卡聲。
沒有水注入	水龍頭關閉	開啟水龍頭
	入水管屈曲	檢查入水管
	水管被阻塞	清潔水管過濾網 (*)
	入水活塞被阻塞	清潔水管活塞 (*)
	機門沒有關好	關好機門沒有。

(*) 請參看有關保養和清洗洗衣機章節。

故障	可能的原因	解決辦法
洗衣機不能排水	排水管被阻塞或屈曲	檢查排水管
	水泵過濾網被阻塞	清潔水泵過濾網 (*)
	衣服沒有平均放在洗衣機裡	把衣服平均分佈在洗衣機裡令洗衣機得到平衡。
洗衣機震動	沒有調校機腳	調校機腳 (**)
	沒有拆除搬運螺絲	拆除搬運螺絲 (**)
	在洗衣機裡只有少量的衣服	這不會妨礙洗衣機運作
	在洗衣機裡的衣服過量和分佈不平均	不要超載洗衣機和平均分佈衣物
	洗衣機接觸著震動快速的物件	防止洗衣機倚著堅硬處

(*) 請參看有關保養和清洗洗衣機章節。

(**) 請參看有關安裝洗衣機章節。

故障	可能的原因	解決辦法
在清潔劑抽屜有 太多泡沫	使用過量的清潔劑	按下啟動 / 暫停按鈕。 要消除泡沫形成，把 一茶匙柔順劑加入半 升水，倒入清潔劑抽 屜。再過 5-10 分鐘 後，按下啟動 / 暫停 按鈕。下次清洗衣服 時，相對調校清潔劑 分量。
	使用錯誤的清潔劑	只用自動洗衣機專用 清潔劑
洗衣效果差	你選的程式不適合衣 服骯髒程度	為衣服骯髒程度選擇 適合的程式 (參看程 式表)
	清潔劑分量不足	根據衣物量和骯髒程 度調校清潔劑分量。
	衣服超過最高洗衣量	放入衣物，衣物量不 要超過最高洗衣量

故障	可能的原因	解決辦法
洗衣效果差	水質太硬。 (污染, 石灰水等)	根據製造商建議的指示 調校清潔劑分量
	沒有平均分佈好衣物。	平均分佈好衣物。
當水滿時排出洗衣機	放置去水管末端太低	把去水管放置在適當的 高度 (**)
清洗時看不見水在滾桶內	沒有故障， 水位在滾桶低處。	_____
在清潔劑殘留物留在衣服上	清潔劑塊沒有溶於水中，可能逗留在衣服上形成白色漬。	在過水程式加入一次額外過水。或在衣服乾後，用刷子幫助清理污漬。
衣物上有灰色漬	這些污漬可能由油，忌廉或膏藥形成。	下次清洗衣服時，使用製造商建議的清潔劑最高分量。
旋乾脫水過程沒有進行或延遲開始	沒有故障。不平均衣物控制系統已生效。	不平均衣物控制系統會嘗試把衣物分佈均勻。當衣物分佈平均，旋乾脫水過程會得以進行。下次記緊把衣服平均分佈在洗衣機裡。

(**) 請參看有關安裝洗衣機章節。

洗衣機裝置了一個系統，可以預防和警告你任何故障，清洗過程中，控制洗衣機穩定操作。

故障	可能的原因	解決辦法
E01	沒有關好機門	關好機門，你可以聽到卡一聲。如果問題持續，拔掉插頭和立即通知最近的合資格服務中心。
E02	水泵出現故障或水泵過濾網被阻塞，或水泵電力故障。	打開水龍頭。主洗可能被截斷。如問題持續，你的洗衣機會自動停止一會。拔掉插頭和關掉水龍頭。立即通知最近的合資格服務中心。
E03	洗衣機的水壓或水位低。	清理水泵過濾網。如問題持續，立即通知最近的合資格服務中心。(*)
E04	洗衣機水量過多	洗衣機會自動排水。根據排水操作，關掉洗衣機並拔下電源插頭。關掉水龍頭，並聯繫最近的授權服務。

(*) 請參看有關保養和清洗洗衣機章節。

酒精酒料

應首先用冷水清洗污漬點，然後用甘油加水擦抹，再用醋加水清洗。



鞋油

用清潔劑輕刮污漬而不要損壞布塊，再用清潔劑清洗。如果仍不能清除污漬，應使用 1 份純酒精品 (96 度) 加 2 份水擦抹，然後用暖水清洗。



茶或咖啡

把布塊的污漬範圍拉直放在一器皿上，然後倒上盡可能熱而你的布塊可承受的水。如衣物種類容許，可漂白水清洗。



朱古力和可可

把衣物浸於冷水，和用肥皂或清潔劑擦抹，然後用最高溫度而你的布塊可以承受的水清洗。如果仍留下油漬，可用氧水擦洗 (3%)。



番茄汁

輕刮乾布而不損毀布塊，再浸在冷水 30 分鐘，然後用清潔劑擦洗。



肉類原湯蛋

用海綿或軟布濕冷水，來擦除乾漬殘留物。用清潔劑擦洗，然後用稀釋漂白水清洗。

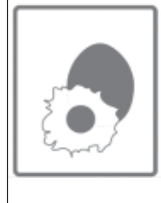

油脂和油漬

首先抹去殘留物。用清潔劑擦淨污漬，然後再用暖肥皂水清洗。



芥醬

首先把甘油放於污漬範圍。用清潔劑磨擦，然後清洗。如污漬沒被清除，用酒精擦洗（在合成纖維和顏色纖維，用 1 份酒精加 2 份水）。



水果

把布塊的污漬範圍拉直放在一器皿上，在污漬圍倒上冷水，千萬不要用熱水。用甘油加冷水洗擦。待 1-2 小時後，用幾滴白醋擦抹，然後過水。



草漬

用清潔劑磨擦污漬範圍。如你的布塊適合使用漂白水，你可用漂白水清洗。而使用酒精洗擦羊毛衣物。（於顏色布塊，用 1 份酒精加 2 份水）。



油漆

在污漬乾透前，用稀釋劑清理。然後用清潔劑洗擦。



火燒漬

如你的布塊適合使用漂白水，你可在清洗的水中加入漂白水。而羊毛織物，用濕透有氧水的布蓋在污漬上，然後用乾布放上熨熱。然後過水，污漬應被清理好。



血漬

把衣物浸在冷水 30 分鐘。如污漬沒被清除，把衣物放於清水加阿摩尼亞 (3 茶匙阿摩尼亞加 4 升水)30 分鐘。



雪糕和奶類

把衣物浸於冷水和用清潔劑揩擦污漬範圍。如污漬沒消失，用適當比例的漂白水洗擦衣物。(不要用漂白水於顏色衣物)



霉漬

霉漬要盡快清理的，應以清潔劑清洗。



墨汁

握著污漬範圍，在冷水下沖洗直至墨水完全被清洗。然後用檸檬汁，清潔劑混合清水洗擦污漬，5 分鐘後過水。



在產品或包裝上，這個符號意味著，本產品不應該被視為家用垃圾。相反，它應被送到適用的廢物收集地方回收電器和電子設備。你將有助於避免潛在關於環境和人類健康的負面影響，這出現由於產品錯誤垃圾程序，確保本產品已適當地徹底消滅。回收的材料將有助於保留自然資源。

有關回收這產品的詳細資料，請聯絡當地政府，家用垃圾徹底消滅服務或你購買產品的商店。



EN

User Manual
Washing Machine

WASHING MACHINE

User

Manual

GM128BL

Gala

CONTENTS

CHAPTER-1: BEFORE USING THE APPLIANCE

- Safety warnings.....4-5
- Correct Usage 6-7
- General warnings 8-9-10-11
- Safety warnings 12-13-14-15-16-17
- Packaging and Environment..... 18
- Savings Information 19

CHAPTER-2: OVERVIEW OF YOUR DEVICE

- General Appearance..... 20-21
- Specifications.....22

CHAPTER-3: INSTALLATION

- Removing transportation safety screws.....23-24
- Adjusting Adjustable Stays..... 25-26-27
- Electrical connection.....28
- Water inlet hose connection 29-30
- Water discharge connection..... 31

CHAPTER-4: INTRODUCTION OF CONTROL PANEL32

- Detergent drawer.....33-34
- Programme knob.....35
- Electronic display.....36-37

CHAPTER-5 PRELIMINARY PREPARATION FOR LAUNDERING

- Separating laundries ^{EN -2-} 38-39

CONTENTS

•	Putting laundries in the machine	40
•	Adding detergent into machine	41
•	Operating your machine.....	42-43-44-45
•	Auxiliary Functions.....	46-47-48-49-50-51
•	Child lock	52
•	Cancelling programme.....	53
•	Finishing programme	54
CHAPTER-6:	PROGRAM TABLE	55-56-57-58-59-60-61-62-63
CHAPTER-7:	MAINTENANCE AND CLEANING OF YOUR MACHINE	
•	Warning.....	64
•	Water inlet filters.....	65
•	Pump filter.....	66-67
•	Detergent drawer.....	68
•	Liquid detergent apparatus.....	68
CHAPTER-8:	FLUSH STOPPER / BODY / DRUM	69
CHAPTER-9:	TROUBLE SHOOTING.....	70-71-72-73-74
CHAPTER-10:	AUTOMATIC FAULT WARNINGS AND WHAT TO BE DONE	75
CHAPTER-11:	PRACTICAL INFORMATION	76-77-78-79
•	How to read the energy label and saving energy	80-81
•	Disposal of your old machine.....	82

CHAPTER -1: BEFORE USING THE APPLIANCE (SAFETY WARNINGS)

Operating voltage / frequency:
(V/Hz) (220-240) V~/50Hz;
Total current (A): 10
Water pressure (Mpa)
Maximum: 1 Mpa / Minimum : 0.1 Mpa
Total power (W) : 2200
Maximum dry laundry capacity (kg): 8

Do not install your machine on a carpet or such grounds that would prevent the ventilation of its base.

The appliance is not intended for use by people (including children) with reduced physical, sensory or mental capabilities, or lack of experience and knowledge unless they have been given supervision or instruction concerning use of the appliance by a person responsible for their safety.

Children should be supervised to ensure that they do not play with the appliance.

Call the nearest authorized service for a replacement if the power cord malfunctions.

CHAPTER -1: BEFORE USING THE APPLIANCE (SAFETY WARNINGS)

Use only the new water inlet hose coming with your machine while making water inlet connections of your machine. Never use old, used or damaged water inlet hoses.

This appliance can be used by children aged from 8 years and above and persons with reduced physical, sensory or mental capabilities or lack of experience and knowledge if they have been given supervision or instruction concerning use of the appliance in a safe way and understand the hazards involved.

Children shall not play with the appliance. Cleaning and user maintenance shall not be made by children without supervision.

Note: For softcopy of this user manual, please contact following address: "washingmachine@standardtest.info". In your e-mail, please provide the model name and serial number (20 digits) which you can find on the appliance door.

CHAPTER -1: BEFORE USING THE APPLIANCE (CORRECT USAGE)

- **Definitely read the user's manual.**
- **Your machine is designed to be used domestically. Commercial use will cause your warranty to be cancelled.**



- Keep your pets away from your machine.
- Please check the packaging of your machine before installation, and the outer surface after the package is opened. Do not operate damaged machines or machines with opened package.
- Have your machine installed only by authorized service. Any interference to your machine by anyone other than authorized services shall cause your warranty to be void.
- The appliance is not intended for use by people (including children) with reduced physical, sensory or mental capabilities, or lack of experience and knowledge unless they have been given supervision or instruction concerning use of the appliance by a person responsible for their safety. Children should be supervised to ensure that they do not play with the appliance.

CHAPTER -1: BEFORE USING THE APPLIANCE (CORRECT USAGE)

- Use your machine only for laundries that have been specified as suitable for washing by the manufacturer.

- **Before operating the washing machine, remove the 4 transportation screws and rubber spacers from the back of the machine. If the screws are not removed, it may cause heavy vibration, noise and product malfunction, (voiding the guarantee).**

- Your machine is not covered under warranty for faults caused by any kind of external factors (pesticides, fire, etc.).

- Please do not throw away this user manual; keep it for future reference. You or somebody else might need it in the future.

Note: Machinery specifications may vary depending on the product purchased.

CHAPTER -1: BEFORE USING THE APPLIANCE (GENERAL WARNINGS)

- The necessary ambient temperature for your machine's ideal operation is 15-25°.
 - Frozen hoses can tear and explode. In regions where temperature is below zero, ambient temperature might endanger the safe operation of electronic card.
 - Please ensure that the clothes you will place in your machine do not contain any foreign substances (nail, needle, coins, lighter, matches, clip etc.) in their pockets. These foreign substances can damage your machine.
 - Before starting to use your machine, you may call the nearest authorized service and request free-of-charge help for installation, operation and use of your machine.
- It is recommended to perform the first washing operation in 90° Cotton programme and without laundry by inserting ½ scale of detergent in 2nd compartment of the detergent drawer.**

CHAPTER -1: BEFORE USING THE APPLIANCE (GENERAL WARNINGS)

- As detergent or softener exposed to air for a long time may cause residues, put your detergent or softener in the detergent drawer at the beginning of every washing.
- It is advised that you unplug your machine and close the water inlet tap if you will not use your machine for a long time. Also, leaving the door of your machine will prevent the formation of bad odors due to humidity.
- Some water might be left in your machine after the trials and tests conducted due to Quality Control procedures. This will not damage your machine.
- Remember that packaging materials of your machine may be dangerous for children.
- Keep the packaging materials in a place where children cannot reach or dispose of them appropriately.
- Use pre-wash programs only for very dirty laundry.

CHAPTER -1: BEFORE USING THE APPLIANCE (GENERAL WARNINGS)

- Never open the detergent drawer when the appliance is running.



- In case of any breakdown, unplug the appliance first and then turn the tap off. Do not attempt to repair by yourself, always contact for authorized service advice.

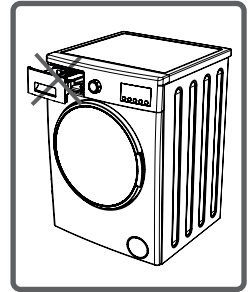

- The amount of laundry you put in your washing machine should not exceed the maximum amount indicated.

- Never force the door to open when the machine is running.

- Washing floury clothes in your machine damages the machine. Do not wash floury clothes in your machine.

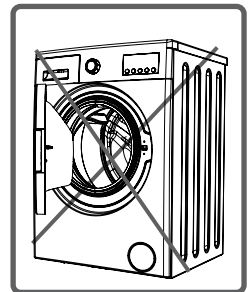

CHAPTER -1: BEFORE USING THE APPLIANCE (GENERAL WARNINGS)

- Please adhere to detergent/fabric conditioner manufacturers' the use of fabric conditioner or similar products in your machine.
- Set up your machine in a place where its door can be completely opened. (Do not set up your machine in places where its door cannot be fully opened.)
- Set up your machine at locations that can be fully ventilated and could have constant air circulation.

CHAPTER -1: BEFORE USING THE APPLIANCE (SAFETY WARNINGS)

You must read these warnings. You can thus protect yourself and your beloved ones against fatal injuries and risks.



DANGER OF GETTING BURNT!



Do not touch discharging hose and water during discharging as the appliance may reach high temperatures when running.

DEATH RISK DUE TO ELECTRICAL CURRENT!



• Do not use multiple receptacles or extension cord.

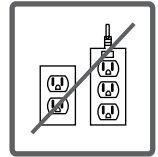

• Do not plug in damaged plug sockets

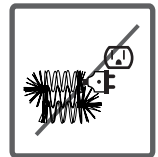

• Never pull the cable when unplugging – always grip the plug itself.

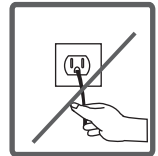

• Do not plug-in or out the plug from the receptacle with wet hands to prevent electrocution!

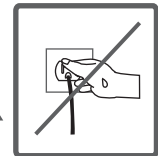

• Never touch the machine with wet hands or feet. 

• Call the nearest authorized service for a replacement if the power cord malfunctions.

Flooding risk!



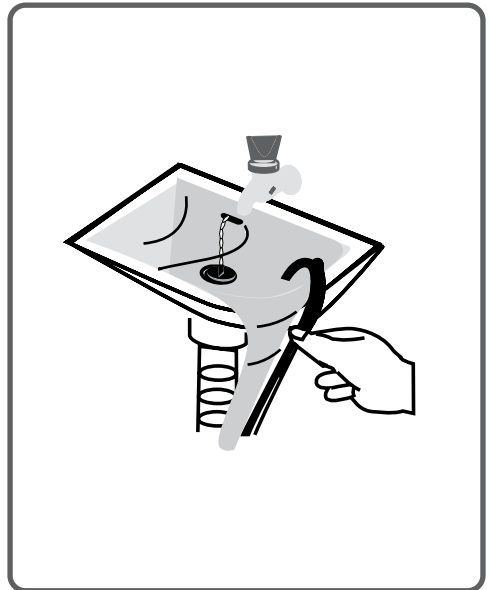

- Check whether the water runs fast or not before placing the discharge hose on the sink.
- Take necessary measures to prevent the slipping of your hose.
- The backfiring force of a hose that is not placed appropriately can displace the hose. Prevent the stopper inside your sink from blocking the sink hole.



Danger of Fire!



- Do not keep inflammable liquids near your machine.
- The sulphure content of paint removers might cause corrosion. For this reason, never use paint-removing materials in your machine.
- Never use products that contain solvent material (like washing gas) in your machine.  
- Remove all the objects in the pockets of your laundries (needle, paperclip, lighter, matches etc.) when placing them your machine.

Fire and Explosion risk may occur.

Fall and injury hazard!



- Do not climb on your machine. The upper table of your machine may break and you might get injured.
- Tidy the hose, cable and packaging of your machine during installation. You might trip over and fall.
- Do not turn your machine upside down, or on its side.
- Do not lift your machine by holding it from extruding parts (detergent drawer, door). These parts might break and cause you to get injured.
- There's the risk of tripping and injury if the materials like hose and cables are not properly stored after your machine is installed.

**Machine must be carried by
2 people or more.**



Child safety!



- Do not leave children unattended near the machine. Children might lock themselves up into the machine and death risk might occur.

- Door glass and surface might be extremely hot while your machine operates. Thus, especially touching the machine might give damage to the skins of children.

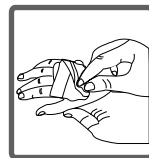

- Keep packaging material away from children.

- Poisoning might occur if the detergent and maintenance materials are consumed, and eyes or the skin might be irritated if they come into contact with the skin. Keep the cleaning materials away from the reach of children.

Removal of packaging materials

Packaging materials protect your machine from any damage that might occur during transportation. Packaging materials are environment friendly as they are recyclable. Recycling material provides both raw material savings and decreases waste production.

Disposal of old machine

Electrical or electronic old devices might still contain salvagable parts. So, never throw away your old devices that you do not use into the waste.



Ensure that the parts of your old electronic or electrical devices are reused by giving them to the gathering centres foreseen by related authorities.

Please ensure your old appliances are kept in an appropriate place for the safety of children until they are taken outside the house.

Some important information to get more efficiency out of your machine:

- The amount of laundry you put in your washing machine should not exceed the maximum amount indicated.

By this way, your machine shall run in saving mode.

- Not using the pre-wash feature for little and normal-dirty laundry shall save electricity and water.

**CHAPTER -2: OVERVIEW OF YOUR DEVICE
GENERAL APPEARANCE**

Electronic display

Programme knob

Upper Tray

Detergent drawer

Container

Cover of pump filter

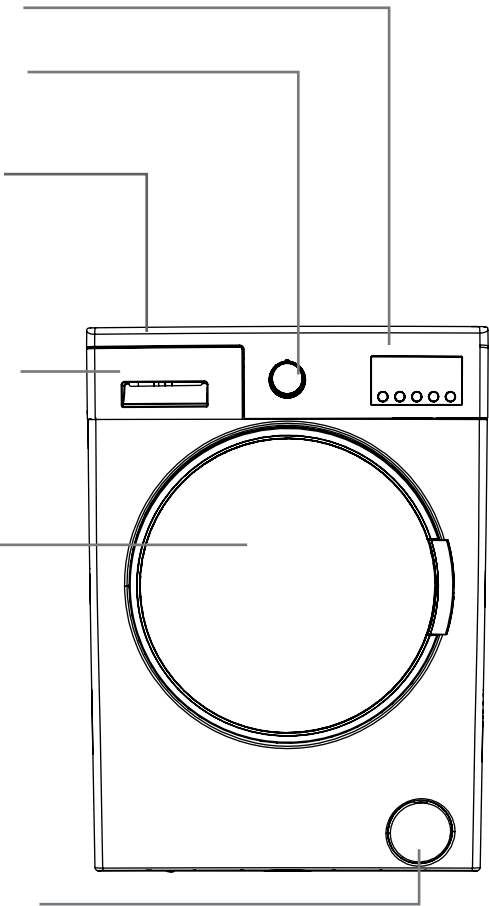

**CHAPTER -2: OVERVIEW OF YOUR DEVICE
GENERAL APPEARANCE**

Transportation Safety
Screw

Water Inlet Valve

Discharging Hose

Power Cable

Transportation Safety
Screw

Transportation Safety
Screw

Transportation Safety
Screw

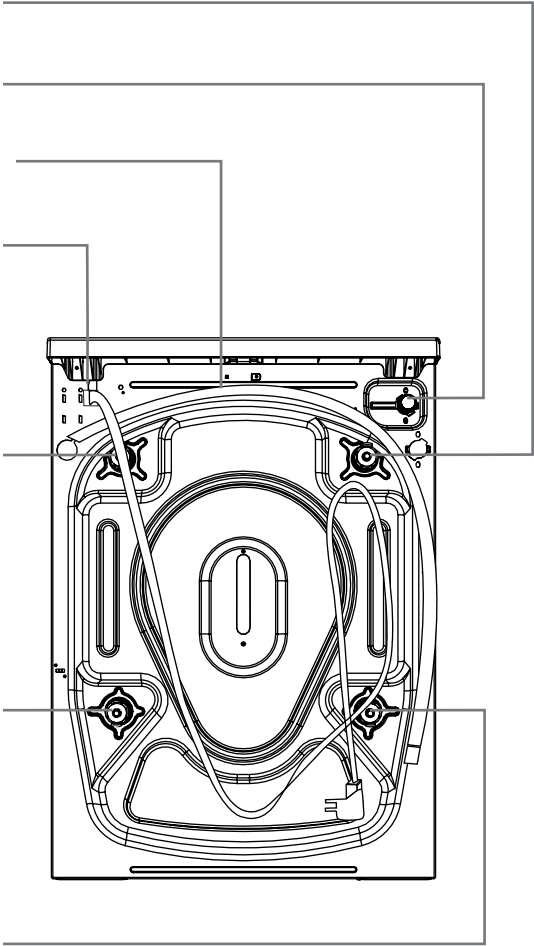

CHAPTER -2: OVERVIEW OF YOUR DEVICE TECHNICAL SPECIFICATIONS

Operating voltage / frequency (V/Hz)	(220-240) V~/50Hz
Total current (A)	10
Water pressure	Maximum: 1 Mpa Minimum : 0.1 Mpa
Total power (W)	2200
Maximum dry laundry capacity (kg)	8
Spinning revolution (rev / min)	1200
Programme number	15
Dimensions (Height x Width x Depth) (mm)	845 x 597 x 557

CHAPTER -3: INSTALLATION OF THE MACHINE REMOVING TRANSPORTATION SAFETY SCREWS



Before operating the washing machine, remove the 4 transportation screws and rubber spacers from the back of the machine. If the screws are not removed, it may cause heavy vibration, noise and product malfunction, (voiding the guarantee).

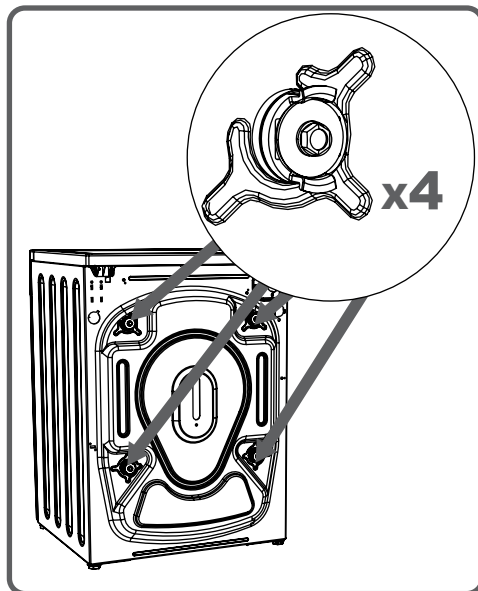

For this reason, transportation safety screws shall be loosened by being rotated in counter-clockwise using an appropriate wrench.

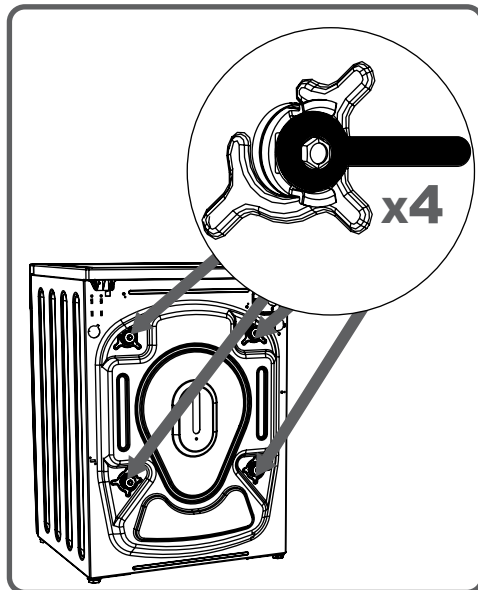

CHAPTER -3: INSTALLATION OF THE MACHINE (REMOVING TRANSPORTATION SAFETY SCREWS)

Transportation screws shall be removed by pulling out.

Fit the plastic transportation screw taps delivered in accessories bag to the places where transportation screws have been removed.

The transportation safety screws should be stored to be used in case of transportation.

NOTE: You should absolutely remove the transportation screws of your machine before the first usage. Faults occurring in the machines operated with transportation screw fitted shall be out of scope of warranty.

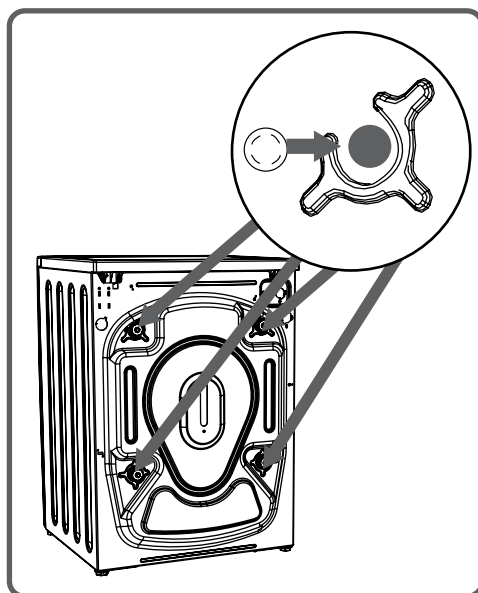
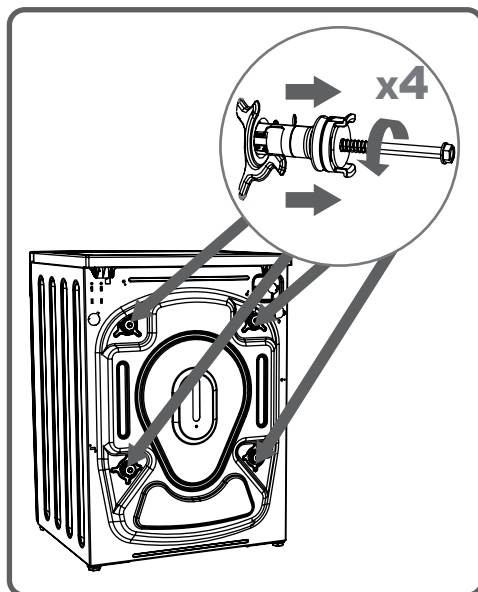

CHAPTER -3: INSTALLATION OF THE MACHINE (Adjusting Adjustable Stays)

- Do not install your machine on a carpet or such grounds that would prevent the ventilation of its base.
- To ensure silent and vibration-free operation of your machine, it should be deployed on a non-sliding and firm ground.
- You can adjust the balance of your machine through the stays.
- Loosen the plastic adjustment nut.

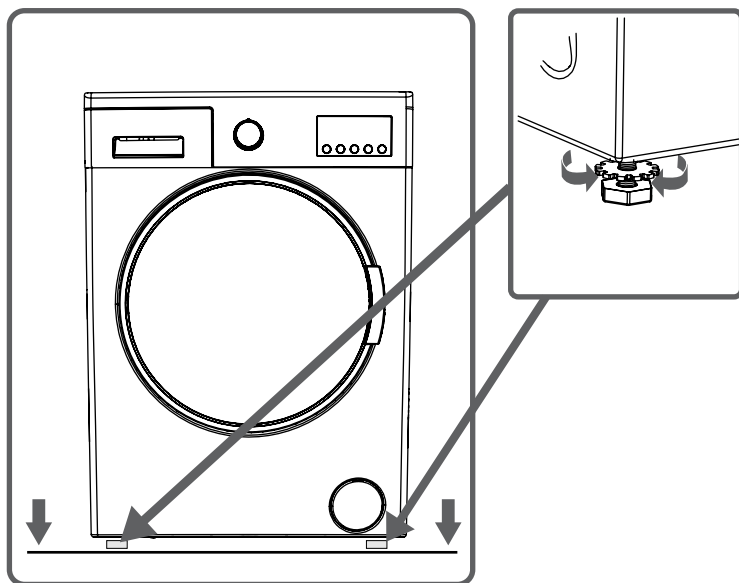

CHAPTER -3: INSTALLATION OF THE MACHINE (ADJUSTING ADJUSTABLE STAYS)

- Adjust the stays upward and downward by rotating them.
- After maintaining the balance, compress the plastic adjustment nut upward again.

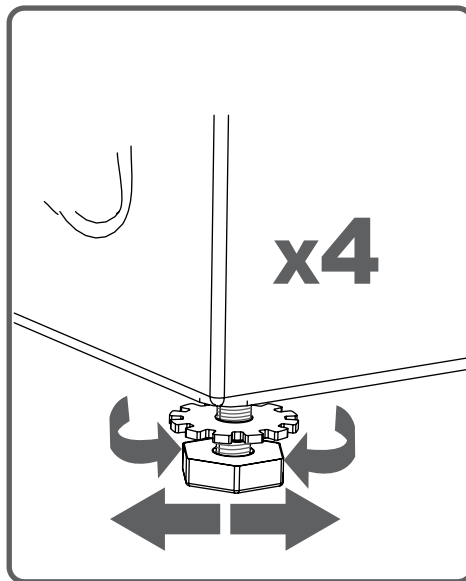

CHAPTER -3: INSTALLATION OF THE MACHINE (ADJUSTING ADJUSTABLE STAYS)

- Never put cardboard, wood or suchlike materials under your machine if you are intending to stabilize the distortions on the ground.



- When cleaning the ground, on which your machine rests, be careful not to disorder stays stabilization.

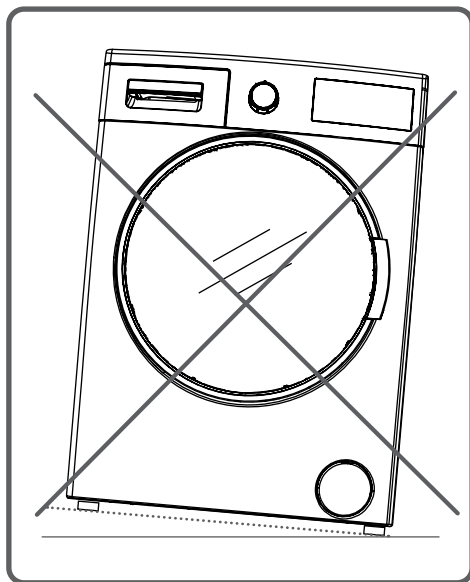

CHAPTER -3: INSTALLATION OF THE MACHINE (ELECTRICAL CONNECTION)

- Your washing machine is set to 220-240V and 50Hz.

- The mains cord of your washing machine is equipped with a specific earthed plug. This plug should always be inserted to a earthed socket of 10 amps.

- The current value of the fuse should be 10 amps. Fuse current value of the power line connected to this plug should also be 10 amperes.

- If you don't have such a receptacle and fuse confirming with this, please have it done by a qualified electrician.

- We do not take the responsibility of the damages that occur due to ungrounded usage.

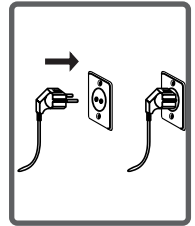

NOTE: Operating your machine under low voltage will cause the life cycle of your machine to be reduced and its performance to be restricted.

CHAPTER -3: INSTALLATION OF THE MACHINE (WATER INLET HOSE CONNECTION)

- Your machine may have either a single inlet (cold) or double water inlets (cold/hot) based on its specifications.

White-capped hose should be connected to cold water inlet and red-capped hose to hot water inlet (applicable for machines with double water inlets).

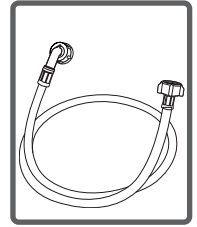

- To eliminate water leakages in points of contact, 1 or 2 nuts are provided in the hose package (applicable for machines with double water inlets).

Fit these nuts to the ends of new water inlet hoses on the side of faucet.

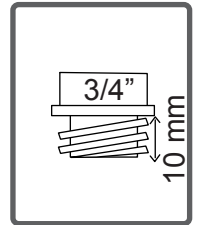

- Mount new water inlet hoses to a 3/4 ", threaded faucet.

- Connect the white-elbow end of the water inlet hoses to the white-filtered water inlet valve on the rear side of the machine and the red-elbow end to red-filtered one (applicable for machines with double water inlets).

Tighten plastic parts of the junctions using your hand.

In uncertain conditions, have the connection works be done by a qualified plumber.

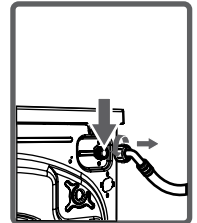

- Flow of water with pressure of 0,1-1 Mpa will allow your machine to operate more efficiently.) (0,1 Mpa pressure means that more than 8 litres of water will flow through a fully-tapped faucet per one minute.)

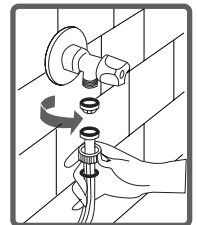

- Ensure that points of contact do not leak by tapping the faucet completely after carrying making the connections.

CHAPTER -3: INSTALLATION OF THE MACHINE (WATER INLET HOSE CONNECTION)

- Ensure that the new water inlet hoses are not bent, broken, crushed and resized.
- If your machine has double hot water inlets, the temperature of hot water inlet should be maximum 70°C.

Note: Use only the new water inlet hose coming with your machine while making water inlet connections of your machine. Never use old, used or damaged water inlet hoses.

CHAPTER -3: INSTALLATION OF THE MACHINE (WATER DISCHARGE CONNECTION)

- The end of water discharge hose can be fitted to a specific apparatus directly attached to dirty water discharge hole or outlet joint of the basin elbow.
- Never attempt to extend the water discharge hose by jointing.
- Do not put discharging hose of your machine in a vessel, bucket or sink.
- Make sure that the water discharge hose does not bend, buckle, be crushed or extended. Please note:
- The water drain hose should be mounted at a height maximum 100 cm from the ground.

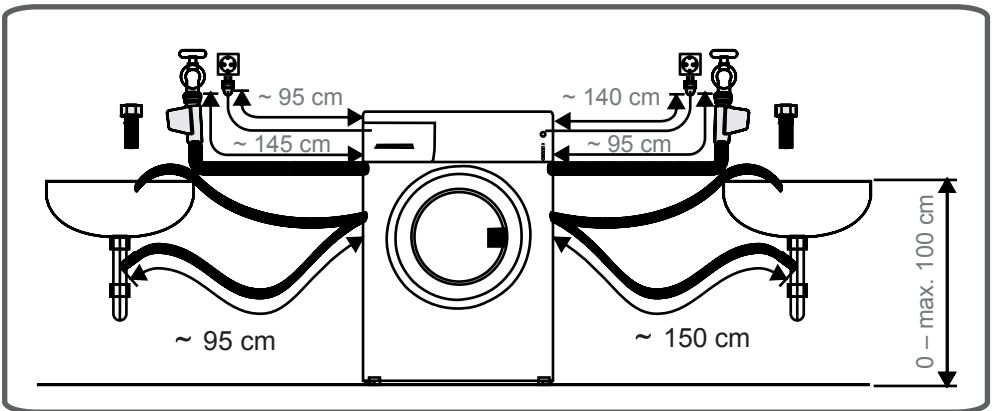
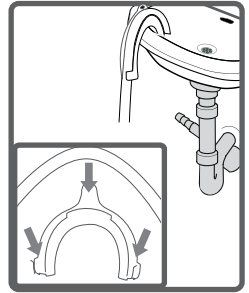
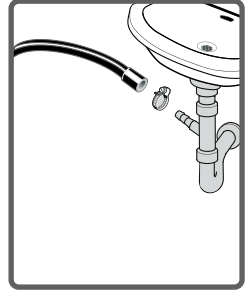

CHAPTER-4: INTRODUCTION OF CONTROL PANEL

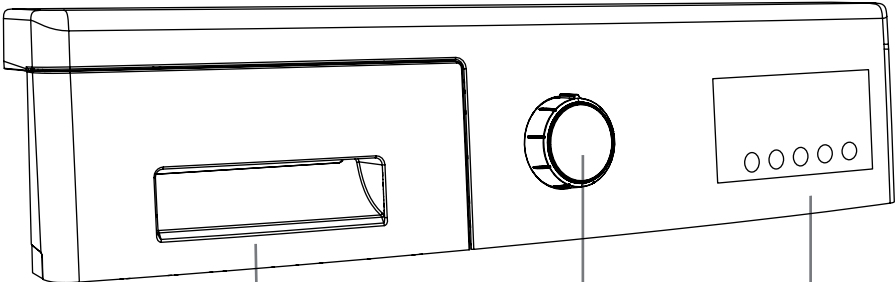

Detergent drawer

Programme knob

Elektronic Display
and Additional
Functions

CHAPTER -4: INTRODUCTION OF CONTROL PANEL (DETERGENT DRAWER)

- You can use the liquid level determination plate when you want to wash your laundry with liquid detergent. You can use your liquid detergents in all programs without prewashing. Place the liquid detergent aparatus in the second compartment (which is available inside the machine) of the detergent drawer (*) and set the detergent amount. (Use the recommended amount of liquid detergent by detergent producers). Do not exceed the MAX level, use only for liquid detergent, do not use this aparatus for powder detergent and take it out.)

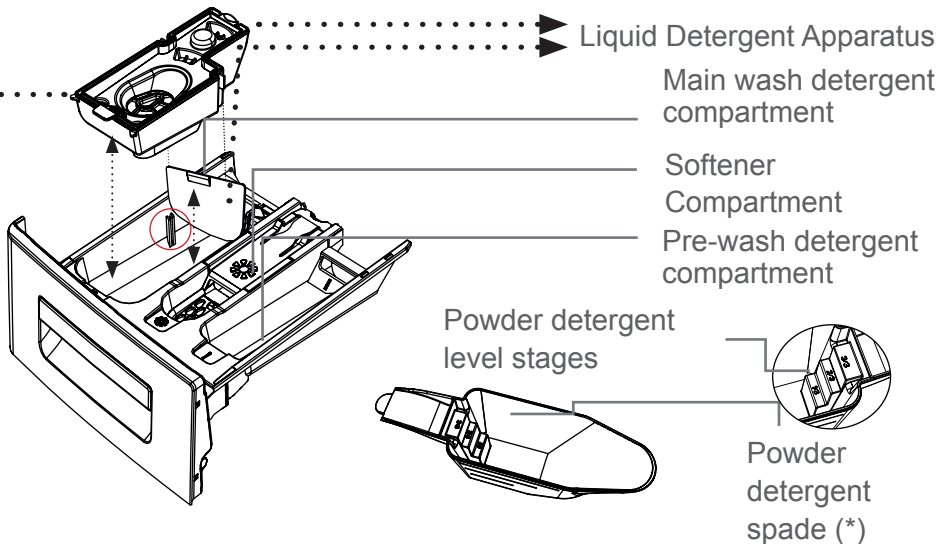
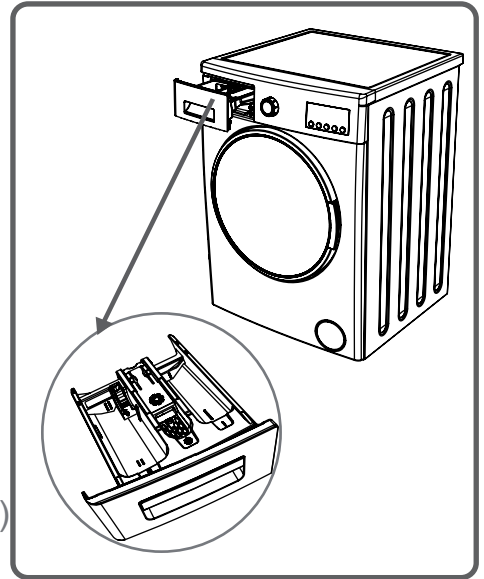

(*) Machinery specifications may vary depending on the product purchased.

CHAPTER -4: INTRODUCTION OF CONTROL PANEL (DETERGENT DRAWER)

SECTIONS

Main wash detergent compartment:

In this compartment, only materials like detergent (liquid or powder), lime preventer and such can be used.

You can find the liquid detergent apparatus inside your machine at first installation. (*)

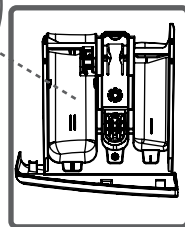
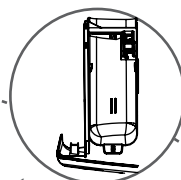

Fabric conditioner, starch, detergent compartment:

You can use softener for your laundry (recommended amount and type by the producer is recommended). Sometimes the fabric conditioners you use for your laundry may remain in this compartment. The reason for this is that the conditioner is not viscous. To prevent this situation, more viscous liquid softeners are recommended to be used or the softener could be thinned and then used.

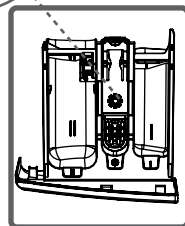
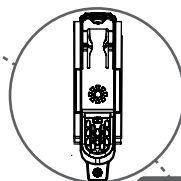

Pre-wash detergent compartment:

This compartment must only be used when the pre-wash feature is selected. Pre-wash feature is recommended for very dirty laundry.

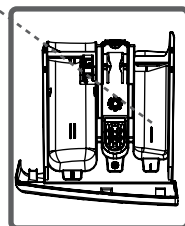
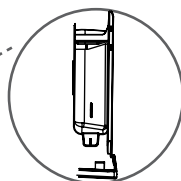

(*) Machinery specifications may vary depending on the product purchased.

CHAPTER -4: INTRODUCTION OF CONTROL PANEL (PROGRAM KNOB)

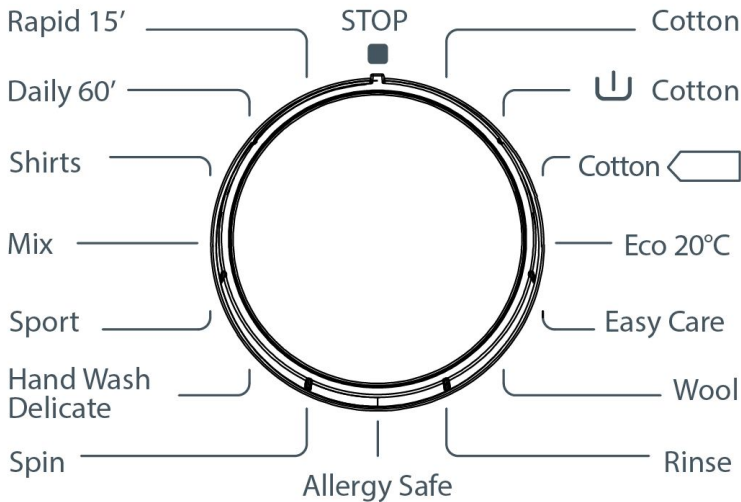

- You can select the programme you want to wash your laundry in through programme knob.
- You may set the programme selection operation by rotating the programme knob in both directions.
- Ensure that the programme knob is exactly on the programme you want to select.

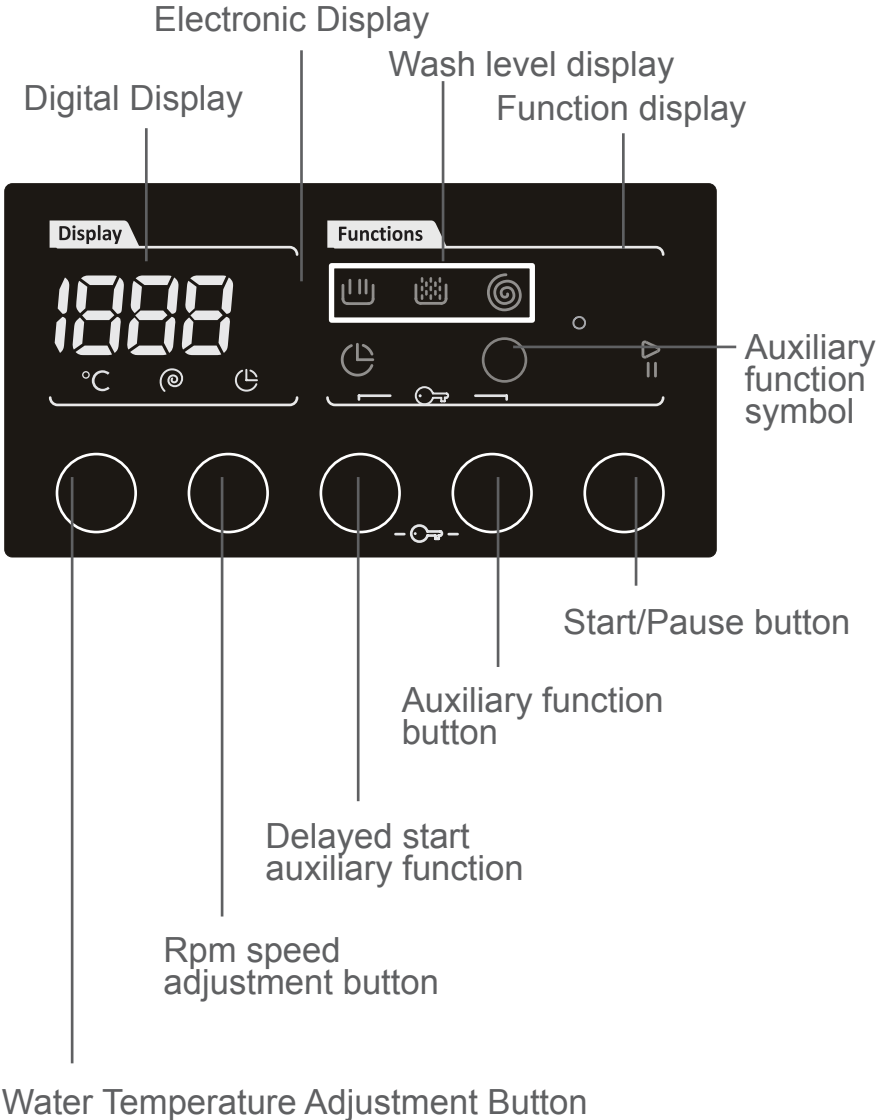

**CHAPTER -4: INTRODUCTION OF CONTROL PANEL
(ELECTRONIC DISPLAY)**



CHAPTER -4: INTRODUCTION OF CONTROL PANEL (ELECTRONIC DISPLAY)

On the electronic display, you may view washing water temperature, spinning revolution speed of your machine, when your machine will finish washing, the auxiliary functions you have selected and at what stage the programme you have chosen is ( → prewash/wash,  → rinsing,  → spinning).

Furthermore, electronic display will warn you by means of fault symbols on the display when a fault occurs on your machine and notify you of the completion of the washing programme by revealing expression of “END” on the display as soon as the washing programme you have selected has finished as well.

CHAPTER -5: PRELIMINARY PREPARATION FOR LAUNDERING (SEPARATING LAUNDRIES)

- Your laundry has product labels on them that specify their specifications. Wash or dry your laundry according to the specifications on the product label.

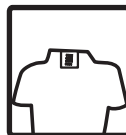

- Separate your laundries according to their types (cotton, synthetic, sensitive, wool etc.), their temperatures (cold, 30°, 40°, 60°, 90°) and degree of contamination (slightly stained, stained, highly stained).



- Never wash your coloured and white laundry together.

- Wash your coloured laundries separately in the first washing as they may bleed.

- Ensure that there are no metallic materials on your laundries or in the pockets; if so, take them up.



CAUTION: WARNING: Faults that will emerge in case of penetration of foreign substances into your machine are not included within the scope of warranty.



- Zip up and button up your laundries.



- Remove the metallic or plastic hooks of tulle curtains or curtains or place them in a washing net or bag and then muzzle them.





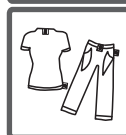







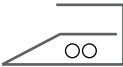
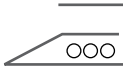
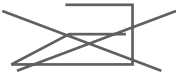

- Reverse textiles such as pants, knitwear, t-shirt and sweat suit.



- Wash socks, handkerchief and suchlike small laundries in a washing net.



CHAPTER -5: PRELIMINARY PREPARATION FOR LAUNDERING (SEPARATING LAUNDRIES)

 Whitening available	 No whitening	 Normal washing
 Ironing temperature is maximum 150°C	 Ironing temperature is maximum 200°C	 No ironing
 Dry cleaning available	 No dry cleaning	 Leave on a flat place
 Hang when wet	 Dry by hanging	 Drying by twirling is not allowed
 Dry cleaning in gas oil, pure alcohol and R113 is allowed	 Perchloroethylene R11, R13, Petroleum	 Perchloroethylene R11, R113, Gas oil

CHAPTER -5: PRELIMINARY PREPARATION FOR LAUNDERING PUTTING LAUNDRIES IN THE MACHINE

- Open the door of your machine.
- Spread your laundries in your machine.

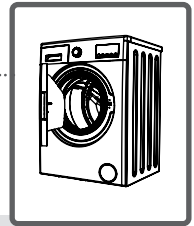

NOTE: Note: Maximum loading capacity may vary based on the laundry type you will wash, degree of contamination and the programme you have chosen. Do not exceed maximum dry loading capacity indicated in the programme table for washing programmes.

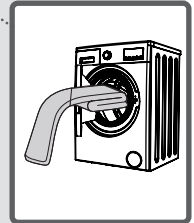

You can take the following table of weights as an example.

LAUNDRY TYPE	WEIGHT (gr)
Towel	200
Linen	500
Bathrobe	1200
Quilt cover	700
Pillow slip	200
Underwear	100
Tablecloth	250

- Put each item of laundry separately.
- Ensure that no laundry is stuck between the cover and bellow seal when closing the door of your machine.

• Push the door of your machine until hearing the locking sound to close it.

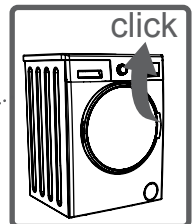

• Close the door of your machine properly, otherwise your machine will not start the washing operation.

CHAPTER -5: PRELIMINARY PREPARATION FOR LAUNDERING (ADDING DETERGENT INTO MACHINE)

The amount of detergent you will put in your machine will depend on the following criteria:

- Your detergent utilization will be based on the degree of contamination of your laundries. Do not prewash your less stained laundries and put your slight amount of detergent in the 2nd compartment of the detergent drawer.
- For your much stained laundries, select a programme including prewashing, and put $\frac{1}{4}$ of the detergent you will put in the detergent drawer in the 1st compartment of the detergent drawer while putting the remaining $\frac{3}{4}$ of it into 2nd compartment.
- Use detergents produced for automatic washing machine in your machine. The amount of detergent you will use for your laundries is printed on the detergent package.
- The higher the degree of hardness of the water the more detergent you will use.
- The amount of the detergent you will use will increase as the amount of your laundries increase.
- Put the softener in the softener compartment in the detergent drawer. Do not exceed the MAX level. Otherwise, softener will flow into washing water through flushing.
- Softeners with high density are required to be thinned to a degree before being put in the drawer. Because high-density softener will clog the flush and avoid the flow of the softener.
- You can use your liquid detergents in all programs without prewashing. For this, fit liquid detergent level plate in the accessories bag or the liquid detergent apparatus (*) into 2nd compartment of the detergent drawer and set the amount of liquid detergent according to the levels on this plate. Remember to detach the liquid detergent plate.

(*)Machinery specifications may vary depending on the product purchased.

CHAPTER -5: PRELIMINARY PREPARATION FOR LAUNDERING (OPERATING YOUR MACHINE)

- Plug your machine in.
- Open the water faucet.
- Open the machine door.

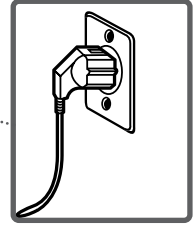

- Spread your laundries in your machine.
- Push the door of your machine until hearing the locking sound to close it.

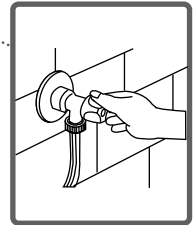

Selecting programme

Select the convenient programme for your laundries on the programme table.

AUXILIARY FUNCTIONS

Before starting the programme, you can optionally select an auxiliary function.

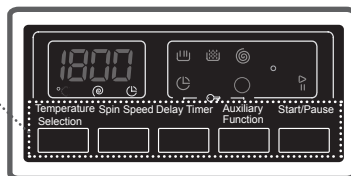

- Press on the button of auxiliary function you would like to select.
- If auxiliary function symbol on electronic display flashes continuously, the auxiliary function you have selected will be activated.
- If auxiliary function symbol on electronic display blinks, the auxiliary function you have selected will not be activated.

Reason for non-activation:

- The auxiliary function you want to use in the washing programme you have selected is not applicable.
- Your machine has passed over the stage, during which the auxiliary function you would like to select would be implemented.
- It is not compatible with an auxiliary function you have selected previously.

HALF-LOAD DETECTION SYSTEM

Your machine features a half-load detection system.

In case you put approximately half or less amount of laundries of maximum laundry capacity in your machine, your machine will run so as to save washing time, water consumption and energy in some programmes. When the half-load function is active, the machine can complete the programme you have set in a shorter time.

CHAPTER -5: PRELIMINARY PREPARATION FOR LAUNDERING AUXILIARY FUNCTIONS

1- Temperature selection

You can select the washing water temperature with the washing water temperature adjustment button.

Whenever you select a new programme, the maximum washing water temperature is shown on the washing water temperature display.

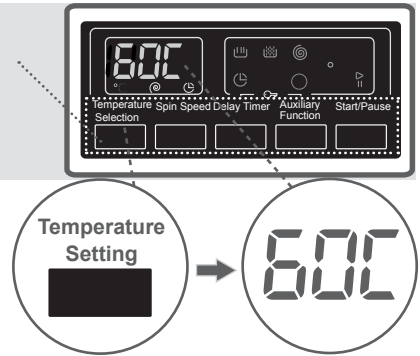

You can gradually decrease the washing water temperature between the maximum temperature and cold washing (--) by pressing washing water temperature adjustment button.

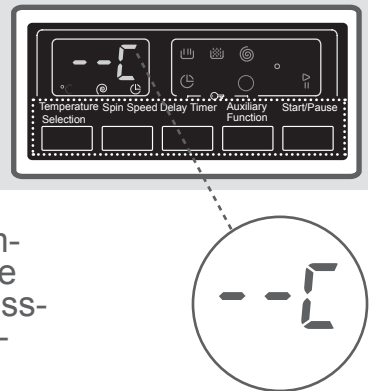

If you have missed the washing water temperature you wanted, you can return to the intended temperature by continuously pressing the washing water temperature adjustment button.

CHAPTER -5: PRELIMINARY PREPARATION FOR LAUNDERING AUXILIARY FUNCTIONS

2- Spin speed selection

You can set the spin revolution for your laundries via revolution speed setting button.

When you select a new programme, the maximum spin revolution speed of the programme you have selected will be viewed on the display of revolution speed.

You can gradually reduce the revolution speed between cancel spinning (--)

options through the maximum spin revolution of the programme selected by pressing revolution speed setting button.

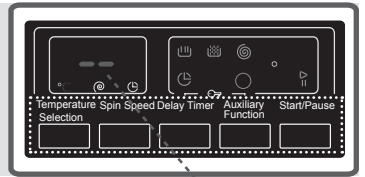
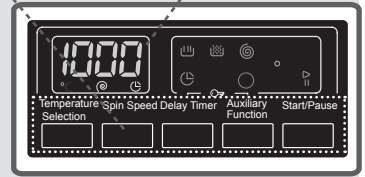
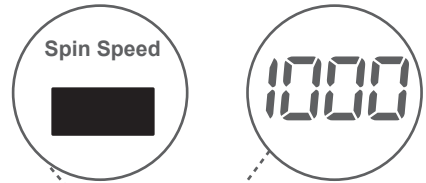

3- Delay timer

By using this auxiliary function, you can set the time when your machine start washing. This time can vary from an hour to 23 hours.

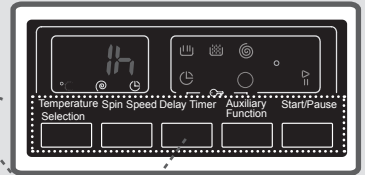

To use auxiliary function of delay timer:

- Press time delay button once.
- Expression of “1 h” will appear on the display. Symbol  will flash on electronic display.
- Press on time delay button until the time, on which you want washing operation to be started.
- To activate the time delay you have selected in the programme, you may press on any auxiliary function button you like except “Start/Standby” button.

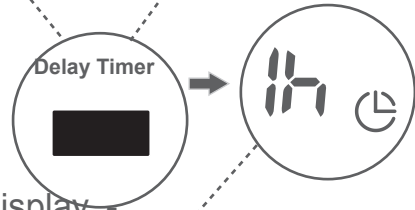

CHAPTER-5: PRELIMINARY PREPARATION FOR LAUNDERING AUXILIARY FUNCTIONS

If you have skipped the time delay you want to set, you can go back to the time desired by keeping pressed on time delay button.

If you want to cancel the time delay, you are required to press the time delay button once.  symbol will no longer flash on electronic display.

To run time delay function, your machine is required to be operated by pressing on Start/Pause button.

4- Easy ironing(*)

You can enable your laundries to be taken out less wrinkled as the washing operation is completed by employing this auxiliary function.

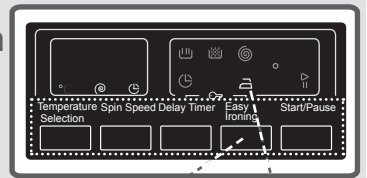

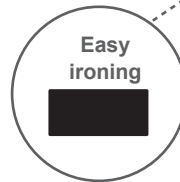

When you press on the easy ironing auxiliary function, the  symbol on the electronic display will flash.

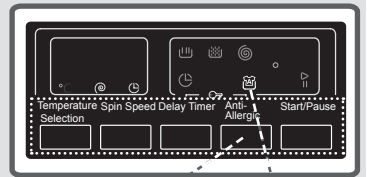

5- Anti-allergic(*)

In the programmes where this auxiliary function is active, your machine will perform an extra rinsing operation on your laundries prior to latest rinsing operation.



When you press on the Anti allergic auxiliary function, the  symbol on the electronic display will flash.





(*) Model Dependant

CHAPTER-5: PRELIMINARY PREPARATION FOR LAUNDERING AUXILIARY FUNCTIONS

6- Rapid wash(*)

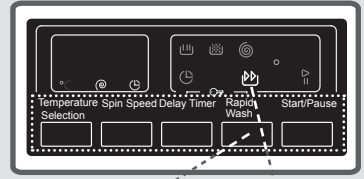
This auxiliary function will enable the washing duration of your laundries that are not very dirty to be shortened.



In case you put half or less than half of the laundry capacity of the washing programme you have selected in your machine, your machine will detect this thanks to automatic half-load detection system and the programme you have selected will wash your laundries in a shorter time to consume less energy and water. If your machine detects half load, the  symbol will automatically flash on electronic display.

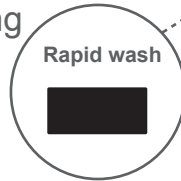

7- Pre-wash(*)

You can expose your very dirty laundries to prewashing operation prior to main washing by using this additional function. When you use this function, you should put detergent in the pre-washing compartment of the detergent drawer.

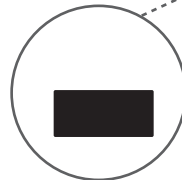
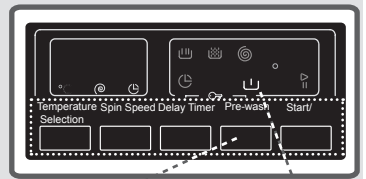



(*)Model Dependant

CHAPTER-5: PRELIMINARY PREPARATION FOR LAUNDERING AUXILIARY FUNCTIONS

8- Extra Rinse(*)

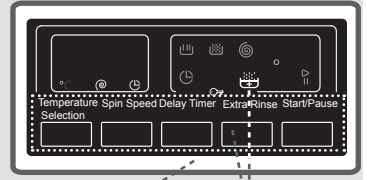
You can make additional rinse operation on your laundry by using this additional function.



You may make the programme active by pressing the extra rinsing auxiliary function button when the led light of the  symbol turns on.

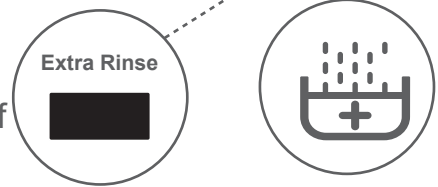

9- Start/Pause button

By pressing on the Start/Pause button, you may start the programme you have selected or suspend a running programme. If you switch your machine to the standby mode, the Start/Standby led on the electronic display will blink.

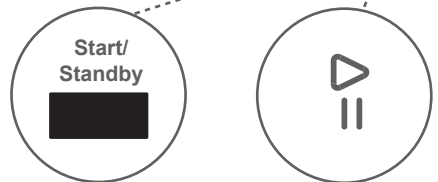
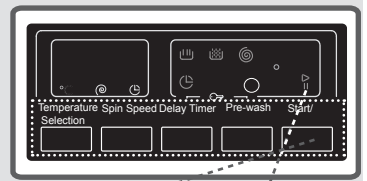

(*)Model Dependant

CHAPTER-5: PRELIMINARY PREPARATION FOR LAUNDERING (CHILD LOCK)

To avoid programme flow from being affected if programme buttons are pressed or programme button is turned when performing washing operation in your machine, child lock is available.

Child lock will be activated in case pressed on both auxiliary functions 3 and 4 at the same time for more than 3 seconds.

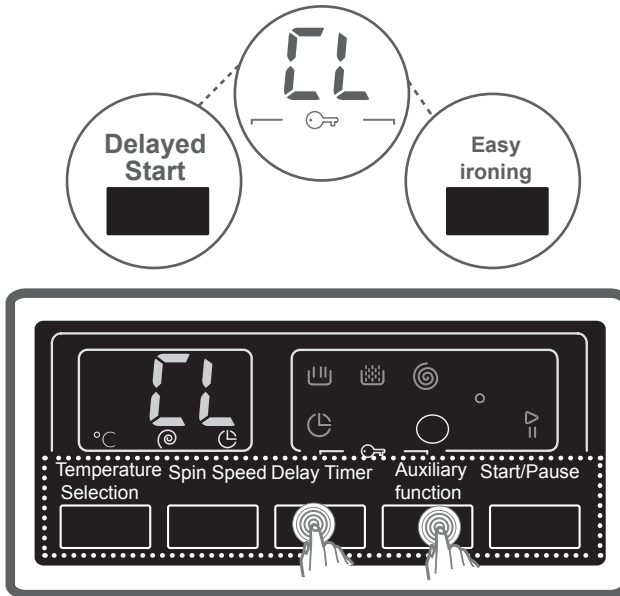

“CL” symbol will flash on the electronic display when activated.

If pressed any button while child lock is active, the “CL” symbol will blink on the electronic display.

If while the child lock is engaged and any programme is running, the programme knob is switched to “O” and another programme is selected, the programme previously selected continues from where it left.

To deactivate it, it will be sufficient to press on the same buttons for more than 3 seconds. When the child lock is deactivated, the “CL” symbol on the electronic display will go off.

If you want to cancel any programme running:

- 1- Switch the programme knob to position “O”.
- 2- Your machine will stop the washing operation and the programme will be cancelled.
- 3- To get rid of the water accumulated in the machine switch the programme knob to any programme.
- 4- Your machine will perform the necessary discharge operation and cancel the programme.
- 5- You can run your machine by selecting a new programme.

CHAPTER-5: PRELIMINARY PREPARATION FOR LAUNDERING FINISHING PROGRAMME

Your machine will stop by itself as soon as the programme you have selected finishes.

- The expression of “END” will flash on the electronic display.

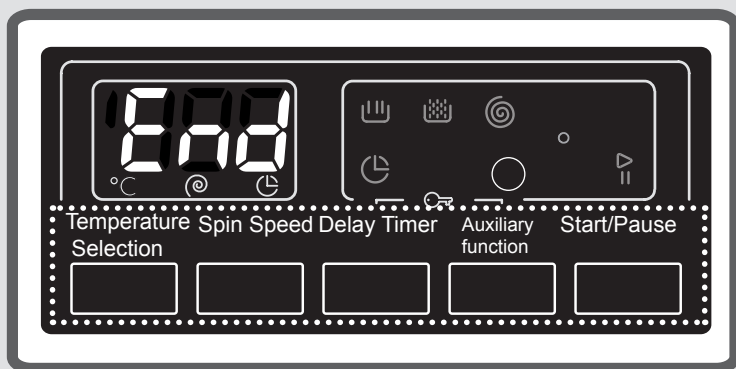

- You can open the machine's door and remove the laundry.
- Leave the door of your machine open to allow the inner part of your machine to dry after removing your laundries.
- Switch the programme knob to position “O”.
- Unplug your machine.
- Turn the water faucet off.

CHAPTER -6: PROGRAM TABLE

COTTON 90°

Washing temperature (°C)	90°
Maximum dry laundry amount (kg)	8,0
Detergent compartment	2
Programme duration (Min.)	187
Laundry type / Descriptions	Very dirty, cotton and flax textiles. (Underwears, linen, tablecloth, towel (maximum 4,0 kg), bedclothes, etc.

Pre-Wash Cotton

Washing temperature (°C)	60°
Maximum dry laundry amount (kg)	8,0
Detergent compartment	1&2
Programme duration	165
Laundry type / Descriptions	Dirty cotton and flax textiles. (Underwears, linen, tablecloth, towel (maximum 4,0 kg), bedclothes, etc.

NOTE: PROGRAM DURATION MIGHT CHANGE ACCORDING TO THE AMOUNT OF LAUNDRY, TAP WATER, AMBIENT TEMPERATURE AND SELECTED ADDITIONAL FUNCTIONS.

CHAPTER -6: PROGRAM TABLE

COTTON ECO

Washing temperature (°C)	60°
Maximum dry laundry amount (kg)	8,0
Detergent compartment	2
Programme duration (Min.)	215
Laundry type / Descriptions	Dirty cotton and flax textiles. (Underwears, linen, tablecloth, towel (maximum 4,0 kg), bedclothes, etc.

NOTE: PROGRAM DURATION MIGHT CHANGE ACCORDING TO THE AMOUNT OF LAUNDRY, TAP WATER, AMBIENT TEMPERATURE AND SELECTED ADDITIONAL FUNCTIONS.

CHAPTER -6: PROGRAM TABLE

ECO 20°

Washing temperature (°C)	20°
Maximum dry laundry amount (kg)	4,0
Detergent compartment	2
Programme duration (Min.)	95
Laundry type / Descriptions	Less dirty, cotton and linen textiles. (Underwear, bedsheet, tablecloth, towel (max. 2 kg) bedcloth, etc.

EASY CARE

Washing temperature (°C)	40°
Maximum dry laundry amount (kg)	3,5
Detergent compartment	2
Programme duration (Min.)	110
Laundry type / Descriptions	Very dirty or synthetic-mixed textiles. (Nylon socks, shirts, blouses, synthetic-including trousers etc.)

NOTE: PROGRAM DURATION MIGHT CHANGE ACCORDING TO THE AMOUNT OF LAUNDRY, TAP WATER, AMBIENT TEMPERATURE AND SELECTED ADDITIONAL FUNCTIONS.

CHAPTER -6: PROGRAM TABLE

WOOL

Washing temperature (°C)	30°
Maximum dry laundry amount (kg)	2,5
Detergent compartment	2
Programme duration	43
Laundry type / Descriptions	Woollen laundries with machine wash labels.

RINSING

Washing temperature (°C)	-
Maximum dry laundry amount (kg)	8,0
Detergent compartment	-
Programme duration	42
Laundry type / Descriptions	If you want to additionally rinse your laundries upon completion of washing operation, you may use this programme for any kind of laundries.

NOTE: PROGRAM DURATION MIGHT CHANGE ACCORDING TO THE AMOUNT OF LAUNDRY, TAP WATER, AMBIENT TEMPERATURE AND SELECTED ADDITIONAL FUNCTIONS.

CHAPTER -6: PROGRAM TABLE

ALLERGY SAFE

Washing temperature (°C)	60°
Maximum dry laundry amount (kg)	4,0
Detergent compartment	2
Programme duration	226
Laundry type / Descriptions	Woollen laundries with machine wash labels.

NOTE: PROGRAM DURATION MIGHT CHANGE ACCORDING TO THE AMOUNT OF LAUNDRY, TAP WATER, AMBIENT TEMPERATURE AND SELECTED ADDITIONAL FUNCTIONS.

CHAPTER -6: PROGRAM TABLE

SPINNING

Washing temperature (°C)	-
Maximum dry laundry amount (kg)	8,0
Detergent compartment	-
Programme duration	17
Laundry type / Descriptions	If you want to additionally wring your laundries upon completion of washing operation, you may use this programme for any kind of laundries.

SENSITIVE/HAND WASH

Washing temperature (°C)	30°
Maximum dry laundry amount (kg)	2,5
Detergent compartment	2
Programme duration	90
Laundry type / Descriptions	Laundry recommended for hand wash or sensitive laundry.

NOTE: PROGRAM DURATION MIGHT CHANGE ACCORDING TO THE AMOUNT OF LAUNDRY, TAP WATER, AMBIENT TEMPERATURE AND SELECTED ADDITIONAL FUNCTIONS.

CHAPTER -6: PROGRAM TABLE

SPORTS WEAR

Washing temperature (°C)	30°
Maximum dry laundry amount (kg)	3,5
Detergent compartment	2
Programme duration	80
Laundry type / Descriptions	Sportswear.

MIXED

Washing temperature (°C)	30°
Maximum dry laundry amount (kg)	3,5
Detergent compartment	2
Programme duration	81
Laundry type / Descrip-	Dirty cotton, synthetics, colour and flax textiles can be washed together.

NOTE: PROGRAM DURATION MIGHT CHANGE ACCORDING TO THE AMOUNT OF LAUNDRY, TAP WATER, AMBIENT TEMPERATURE AND SELECTED ADDITIONAL FUNCTIONS.

CHAPTER -6: PROGRAM TABLE

BLOUSES / SHIRTS

Washing temperature (°C)	60°
Maximum dry laundry amount (kg)	4,0
Detergent compartment	2
Programme duration	112
Laundry type / Descriptions	Dirty cotton, synthetic and synthetic-mixed shirts and blouses can be washed together.

DAILY 60 min.

Washing temperature (°C)	60°
Maximum dry laundry amount (kg)	4,0
Detergent compartment	2
Programme duration	60
Laundry type / Descrip-	You can wash your dirty cotton, colour and flax textiles at 60°C in 60 minutes.

If you have the rapid washing auxiliary function in your machine, then if you put 2 kg or less laundry in your machine, your machine will automatically wash for laundry for 30 minutes.

NOTE: PROGRAM DURATION MIGHT CHANGE ACCORDING TO THE AMOUNT OF LAUNDRY, TAP WATER, AMBIENT TEMPERATURE AND SELECTED ADDITIONAL FUNCTIONS.

CHAPTER -6: PROGRAM TABLE

RAPID 15 min.

Washing temperature (°C)	30°
Maximum dry laundry amount (kg)	2,0
Detergent compartment	2
Programme duration	15
Laundry type / Descriptions	You can wash your slightly stained, cotton, colored and flax textile within only 15 minutes.

NOTE: As the washing period is short, less amount of detergent is required to be used compared to other programmes. The programme period will increase if your machine detects instable loading. You can open the door of your machine 2 minutes after the completion of washing operation. (The duration of 2 minutes required to open the door of your machine is not included in the washing period.)

CHAPTER -7: MAINTENANCE AND CLEANING OF YOUR MACHINE (WARNING)



Unplug your machine before starting the maintenance and cleaning of your machine.

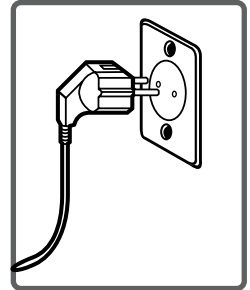

Turn the tap water off before starting the maintenance and cleaning of your machine.

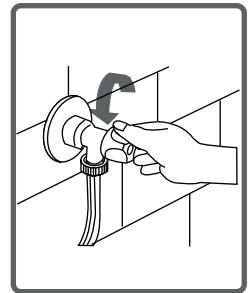

CAUTION: Your machine's parts might be damaged if cleaners with solvent agents are used.

Do not use cleaning materials with solvent agents.

CHAPTER -7: MAINTENANCE AND CLEANING OF YOUR MACHINE (WATER INLET FILTERS)

Filters to avoid dirt and foreign substances in the water from penetrating into the machine are available both on the side of faucet and on the ends of water valves along the water inlet hose of your machine.

If your machine cannot intake sufficient amount of water despite water faucet being open, these filters should be cleaned.

(It is recommended that you clean your pump filter once in 2 months.)

- Detach the water inlet hoses.
- Remove the filters on water inlet valves using pliers and then clean it with a brush in water.
- Disassemble the filters on the side of faucet side of water inlet hoses manually and clean it.
- Having the filters cleaned, you can fit them in the same way reversely.

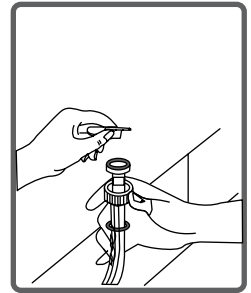
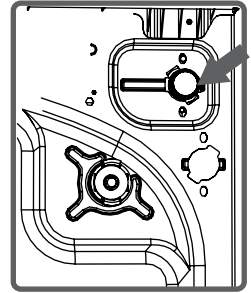

CAUTION:

Filters of water inlet valves may be clogged due to contaminated water faucet or lack of necessary maintenance or valves may be broken down, causing water leaking into your machine continuously.



The breakdowns that may arise due to these reasons are out of the scope of warranty.

CHAPTER -7: MAINTENANCE AND CLEANING OF YOUR MACHINE (PUMP FILTER)

A filter system which avoids threads remaining from your laundries and tiny materials from entering into the pump during water discharging operation carried out by your machine after completing washing so prolonging the lifecycle of your pump is available. It is recommended that you clean your pump filter once in 2 months. To clean pump filter:

- To open the pump cover, you can use the powder detergent spade (*) or liquid detergent level plate coming out of your machine.

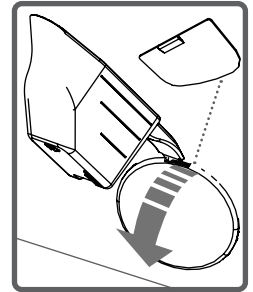

- Fit the end point of the plastic part to the gap of the pump cover and push it back. This will open the cover.

- Before opening the filter cover, settle a vessel in front of the filter cover to prevent the water remained in the machine from flowing on the ground.

- Loosen the filter cover in counter-clockwise and then empty water.

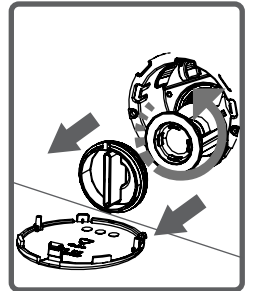

Note: You may have to empty the water collection vessel several times according to the amount of water in the machine.

(*) Machinery specifications may vary depending on the product purchased.

CHAPTER -7: MAINTENANCE AND CLEANING OF YOUR MACHINE (PUMP FILTER)

- Clean the foreign materials in the filter with a brush.

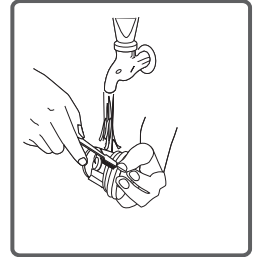

- After cleaning the filter, fit the filter cover and tighten it by rotating it in clockwise direction.

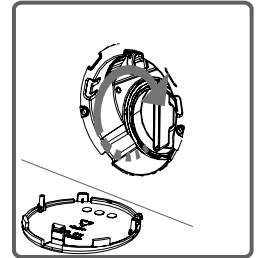

- While closing the pump cover, ensure that the parts on the inner side of the cover to match the holes on the front panel side.

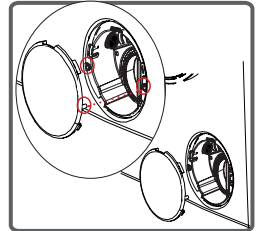

- You can reattach the pump cover in the reverse order that you removed it.

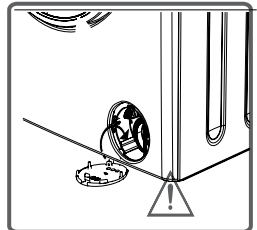

WARNING!

As water in the pump may be hot, wait until it cools down.

CHAPTER -7: MAINTENANCE AND CLEANING OF YOUR MACHINE (DETERGENT DRAWER)

Your detergents may deposit residue in detergent drawer and housing of detergent drawer over time.

To clean the residue formed, disassemble the detergent drawer in particular periods. It is recommended that you clean your pump filter every 2 months.

To eject the detergent drawer:

- Pull the detergent drawer up to the end
- Keep on pulling by depressing on the section shown below in the detergent drawer and keep pulling and then unsettle the detergent drawer.

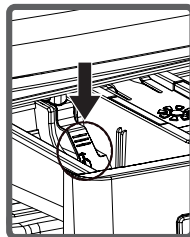
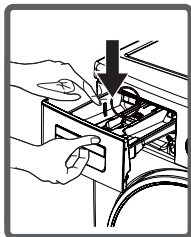
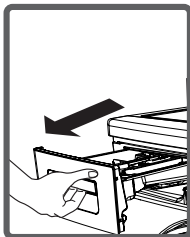

- Flush it using a brush.
- Collect residues in the housing of the detergent drawer without dropping them inside the machine.
- Assemble the detergent drawer after drying it using a towel or dry cloth.
- Do not wash your detergent drawer in dishwasher.



Liquid Detergent Apparatus (*)

Take out the liquid detergent level apparatus for cleaning and maintenance purposes as shown in the picture and clean well detergent residues. Put the apparatus back into its place. Make sure no residues are left inside.

(*) Machinery specifications may vary depending on the product purchased.

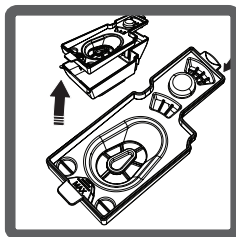
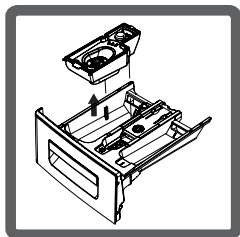

Flush stopper

Disassemble the detergent drawer. Disassemble the flush stopper and clean the softener residues completely. Refit the flush stopper after cleaning it. Check whether it has settled properly.

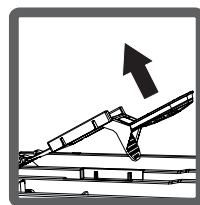
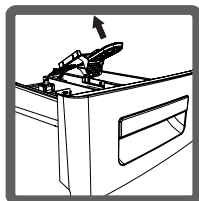
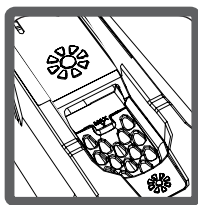

Body

Clean the outer body of your machine with warm water and a non-inflammable cleaning agent that will not abrade the body of your machine. After rinsing with some water, dry it using a soft and dry cloth.

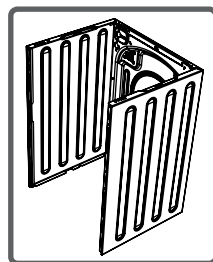

Drum

Do not leave metallic objects such as needles, paper clips, coins etc. in your machine. This objects lead to formation of rust stains in the drum. To clean such rust stains, use a non-chlorine cleaning agent and follow the instructions of manufacturers of the cleaning agent. Never use wire wool or similar hard objects for cleaning rust stains.

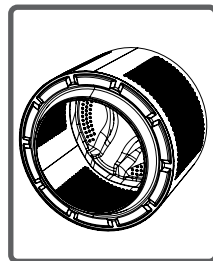

CHAPTER -9: TROUBLESHOOTING

All repairing operations required for your machine should be carried out by our authorised service. If your machine requires a repair or if you cannot remove the fault by the help of the information provided as follows:

- Unplug your machine.
- Turn the water faucet off.

FAULT	POSSIBLE CAUSE	TROUBLE-SHOOTING
Your machine does not start.	It is not plugged.	Plug machine in.
	Fuses out of order.	Replace the fuses.
	Electricity cut-off.	Check mains power.
	Start/Pause button not pressed.	Press on Start/Pause button.
	Programme dial 'stop' position.	Switch the programme button to the desired position.
	The machine door is not completely closed.	Close the machine door.
Your machine does not intake water.	Water tap is turned off.	Turn your faucet on.
	Water inlet hose may be twisted.	Check water inlet hose and untwist.
	Water inlet hose clogged.	Clean water inlet hose filters. (*)
	Valve inlet filter clogged.	Clean the valve inlet filters. (*)
	The machine door not completely closed.	Close the machine door.

(*) See the chapter regarding maintenance and cleaning of your machine.

CHAPTER -9: TROUBLESHOOTING

FAULT	POSSIBLE CAUSE	TROUBLE-SHOOTING
Your machine does not discharge water.	Discharging hose clogged or twisted.	Check the discharging hose, then either clean or untwist.
	Pump filter clogged.	Clean the pump filter. (*)
	Laundries settled in the machine non-homogeneously.	Spread your laundry in the machine evenly.
Your machine vibrates.	The feet of your machine have not been adjusted.	Adjust the feet on your machine. (**)
	Safety stays fitted for transportation not disassembled.	Disassemble the safety stays of your machine. (**)
	Less amount of laundry in the appliance.	This will not block operation of your machine.
	Your machine is overloaded with laundry or laundry settled unevenly.	Do not put in laundry more than the amount recommended and settle the laundry in the machine evenly
	Your machine rests on a hard surface.	Prevent your machine from resting on hard surfaces.

(*) See the chapter regarding maintenance and cleaning of your machine.

(**) See the chapter regarding installation of your machine.

CHAPTER -9: TROUBLESHOOTING

FAULT	POSSIBLE CAUSE	TROUBLESHOOTING
Excessive foam is formed in the detergent drawer.	Excessive amount of detergent used.	Press on Start/Pause button. To eliminate foam formation, mix a spoon of softener with half litres of water, and pour the mixture in the detergent drawer. After 5-10 minutes, Press on Start/Pause button again. In your next washing operation, Adjust the detergent dose accordingly.
	Wrong detergent used.	Use detergents produced only for automatic washing machines in your machine.
Unsatisfactory washing result.	The contamination degree of your laundries does not match the programme you have chosen.	Select the programme appropriate for the contamination degree of your laundries. (See programme table)
	Amount of detergent used insufficient.	Adjust the amount of detergent based on the amount and contamination degree of your laundries.
	Laundries in excess of maximum capacity put in your machine.	Load your machine with laundries, amount of which will not exceed maximum laundry capacity.

CHAPTER -9: TROUBLESHOOTING

FAULT	POSSIBLE CAUSE	TROUBLE-SHOOTING
Unsatisfactory washing result.	Water being hard. (Contaminated, lime water etc.)	Adjust the amount of detergent based on the instruction of detergent manufacturer.
	Laundries distributed in your machine non-homogenously.	Spread your laundries in the machine properly and homogeneously.
As soon as the machine is loaded with water, water discharges.	The end of water discharging hose is too low for the machine.	Set the water discharging hose on appropriate height. (**)
No water appears in the drum during washing.	No fault. Water is in the unseen part of the drum.	—————
Laundries have detergent residues on them.	Non-dissolving particles of some detergents may stick to your laundries as white spots.	Perform an Extra rinse by setting your machine to “Rinsing” programme, or clean the spots using a brush after your laundries dry.
Grey spots appear on the laundries.	The reason for such spots may be oil, cream or ointment.	Apply the maximum amount of detergent instructed by the detergent manufacturer in the next washing operation.

(**) See the chapter regarding installation of your machine.

CHAPTER -9: TROUBLESHOOTING

FAULT	POSSIBLE CAUSE	TROUBLESHOOTING
<p>Spinning operation is not performed or runs late.</p>	<p>No fault. Unbalanced load control system has been activated.</p>	<p>Unbalanced load control system will try to spread your laundries homogeneously. Spinning operation will begin after your laundry is spread. Place the laundry in the machine in a balanced fashion the next time.</p>

CHAPTER -10: AUTOMATIC FAULT WARNINGS AND WHAT TO BE DONE

Your machine is equipped with the systems which are capable of both taking necessary precautions and warning you in case of any breakdown by means of continuous self-checking during washing operations.

TROUBLE CODE	POSSIBLE FAULT	WHAT TO DO
E01	The door of your machine is left open.	Close the machine door. If your machine persists to indicate fault, turn off your machine, unplug it and contact the nearest authorised service immediately.
E02	The water pressure or the water level inside the machine is low.	Turn on the faucet. Mains water may be cut-off. If the problem still continues, your machine will stop after a while automatically. Unplug the machine, turn off your faucet and contact the nearest authorised service.
E03	The pump is faulty or pump filter is clogged or electrical connection of the pump is faulty.	Clean the pump filter. If the problem persists, contact the nearest authorised service. (*)
E04	Your machine has excessive amount of water.	Your machine will discharge water by itself. Pursuant to discharging operation, turn off your machine and unplug it. Turn off your faucet and contact the nearest authorised service.

(*) See the chapter regarding maintenance and cleaning of your machine.

Alcoholic drinks: Spotted area should initially be washed using cold water, and then be wiped with glycerine and water and rinsed with vinegar-mixed water.

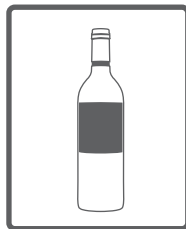

Shoe shine: Spot should be rubbed out gently without damaging the cloth and be scrubbed and rinsed with detergent. If not removed, it should be scrubbed using the mixture obtained by adding 1 scale of alcohol (96°) into 2 scales of water, and then be washed with warm water.

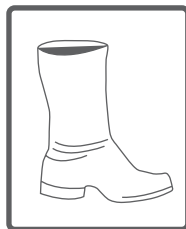

Tea and coffee: Stretch the spotted area of your laundry throughout the opening of a vessel, and pour hot water as much as the type of your laundry can resist. In case the type of your laundry permits, wash with bleach.



Chocolate and cocoa: After submerging your laundries in cold water and rubbing it using soap or detergent, wash it in temperature that fabric type of your laundry can resist. In case the oil stain is still visible, wipe with oxygen water (3%).



Tomato paste: After rubbing out the dried substances without damaging your laundry, submerge it in water for 30 minutes, and then scrub and wash it with detergent.

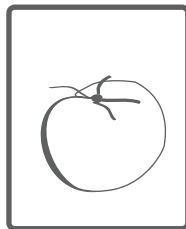

Bouillon-Egg: Remove dried spot residues on your laundry, and then wipe it with a sponge or soft cloth submerged in cold water previously. Scrub with detergent, wash with diluted bleach.

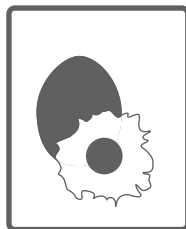

Grease and oil stains: Firstly, wipe the residues. Scrub the spot with detergent and wash it with warm soapy water.



Mustard: Apply glycerine on spotted area. Scrub with detergent and wash. If the spot cannot be removed, wipe with alcohol. (For synthetic and colour fabrics, a mixture of 1 scale of alcohol and 2 scales of water should be used)

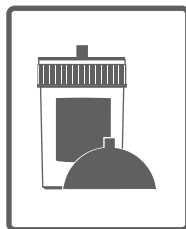

Fruit: Stretch the spotted area of your laundry throughout the opening of a vessel, and pour cold water on it. Do not pour hot water on the spot. Wipe with cold water and apply glycerine. Allow 1-2 hours, wipe with a few drops of white vinegar, and rinse it.

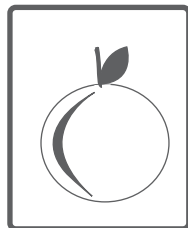

Grass stain: Wipe the stained part with detergent. If the type of your cloth permits bleach using, wash with bleach. Wipe your woollen laundries with alcohol. (For colour fabrics, a mixture of 1 scale of pure alcohol and 2 scales of water)



Oil paint: Spot should be removed by applying thinner before drying. Then it should be wiped with detergent and washed.

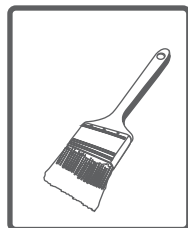

Burn stain: If your laundry is suitable for applying bleach, you can add bleach into washing water. For wool fabric, a cloth previously submerged in oxygen water should be covered over the stain and it should be ironed after putting a dry cloth on this cloth. It should be washed after being rinsed properly.



Blood stain: Submerge your laundries in cold water for 30 minutes. If the stain is not removed, then submerge in a mixture of water and ammoniac (3 spoons of ammoniac in 4 litres of water) for 30 minutes.

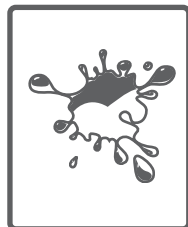

Crema, ice cream and milk: Submerge your laundries in cold water and scrub the spotted area with detergent. If the spot is not removed, apply bleacher to the extent suitable for your laundries. (Do not use bleacher for colour laundries.)



Mould: Mould stains should be cleaned as soon as possible. Stain should be washed with detergent water, nevertheless if it cannot be removed, it should be wiped with oxygen water (3%).

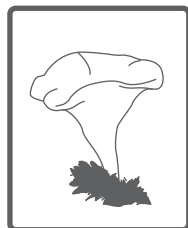

Ink: Subject the spotted area to running water and wait until the flow of inked water ends. Then wipe it with lemon-added water and detergent, and wash it after allowing 5 minutes.

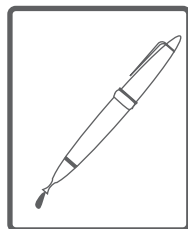

DESCRIBING ENERGY LABEL AND SAVING ENERGY

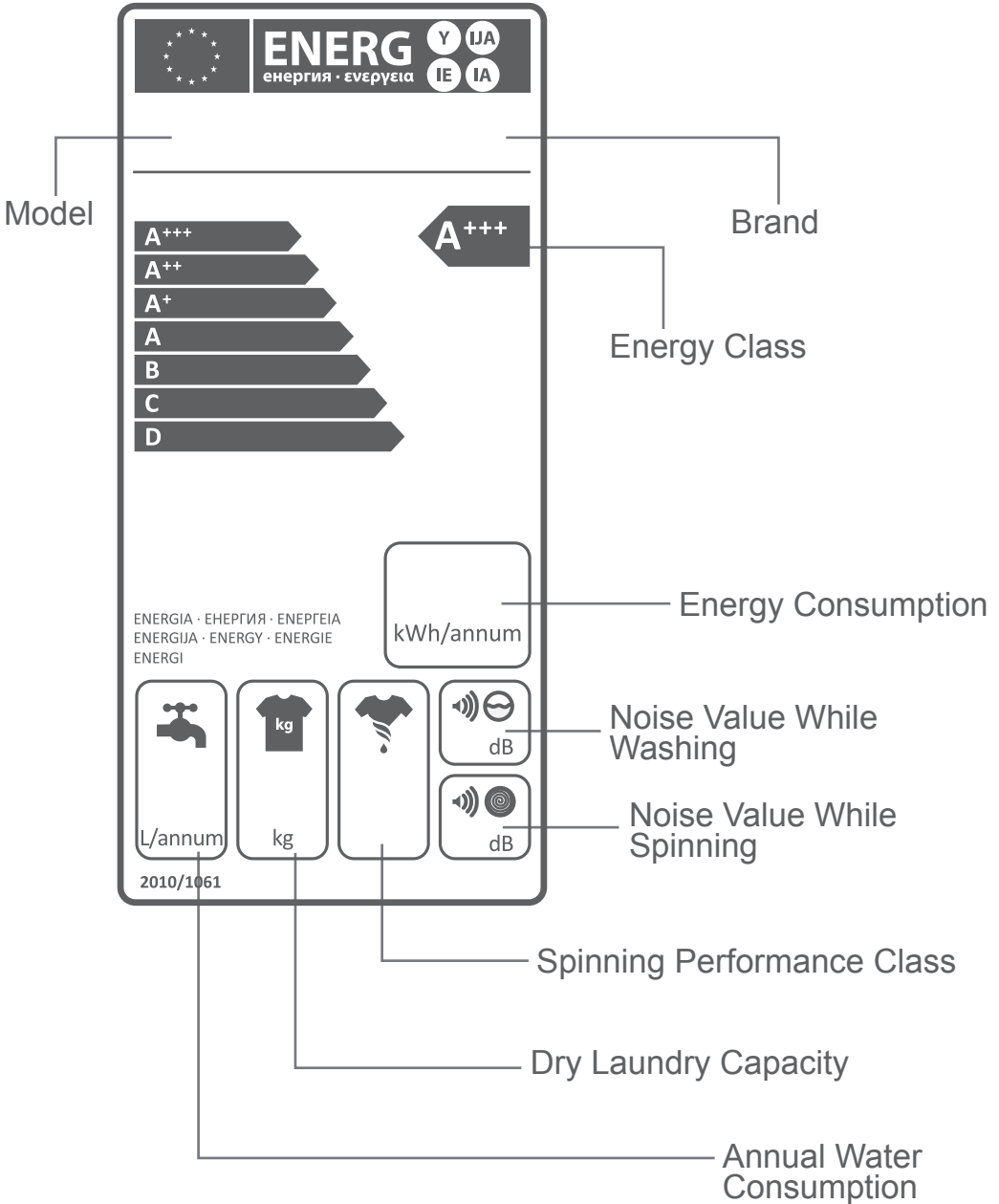

DESCRIBING ENERGY LABEL AND SAVING ENERGY

Energy and water consumption may vary based on water pressure, water hardness, water temperature, ambient temperature, laundry amount, additional function selection, voltage fluctuations. It will reduce energy and water consumption to use your machine with the laundry capacity proposed for the selected programme, wash your laundries less dirty or daily laundries in short programmes, carry out cleaning and maintenance periodically, use your machine in convenient time intervals specified by electricity vendor.

DISPOSAL OF YOUR OLD MACHINE

This symbol on the product or package implies that the product should not be treated as domestic waste. Instead, it should be delivered to applicable waste collection places recycling electrical and electronic equipment.

You will contribute to avoid potential negative results regarding environment and human health, which will arise due to wrong waste procedure for the product by ensuring that this product is annihilated properly. Recycling materials will help natural resources be preserved.

For more detailed information regarding recycling of this product, please contact local municipality, domestic waste annihilation service or the shop you have purchased the product.



PAGE LEFT BLANK INTENTIONALLY

PAGE LEFT BLANK INTENTIONALLY

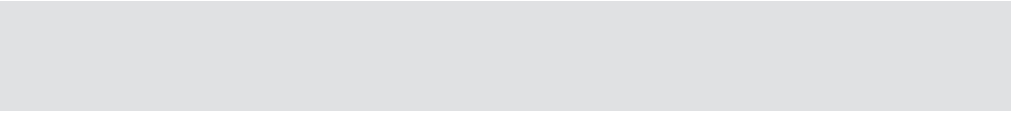

CE

52299456